



**B** **BORGERT**  
PAVERS | SLABS | WALLS | EST. 1923



# PRODUCT RESOURCE & INSTALLATION GUIDE

---

TWENTY TWENTY RESOURCE





BORGERT PRODUCTS

# COMES WITH A PEDIGREE.

Family owned and operated, Borgert Concrete Products, Inc. was established in 1923 by Lawrence A. Borgert in East St. Cloud, MN. In 1953, Lawrence's son, Kenneth J. Borgert, took over the business and relocated it to its current location in St. Joseph. As sole owner of Borgert Products, since 2006, I am proud to uphold the same values and traditions of quality products and service unmatched in the industry just as my Grandfather and Father did. In 97 years, we have survived some challenging times which has made us a strong leader in our industry today. We started out manufacturing block and precast and have evolved into Interlocking Concrete Paving Stones, Retaining Walls and Slabs, with 2020 marking the 43 year anniversary of manufacturing paving stones. Thanks to the creativity of our people and our engineering, we continue to design new and improved products, providing our customers better selections to build their dream landscapes.

Ultimately, our Company's success is due to the hardworking team of people at Borgert Products. We are fortunate to have skilled and knowledgeable people who work hard to produce quality products, with impeccable service and commitment to our customers. In the 97 years that Borgert has been in business, many changes have occurred and I know that the founders of our Company would be as proud as I am for where we are today.

CEO









# TABLE OF CONTENTS

---

№: 4	<b>Traditional Paving Stones</b>
№: 4	Cobble Series™
№: 7	Holland Stone™
№: 9	Bavaria II
№: 10	Vavel II™
№: 11	<b>Strassen® Series Tumbled Paving Stones</b>
№: 11	Strassen® Series Cracovia
№: 12	Strassen® Series Classic
№: 15	Strassen® Series Bavaria
№: 17	Strassen® Series Vavel Stone
№: 18	<b>Installation Guide for ICP</b>
№: 18	Paving Stone Installation Guide
№: 20	Cross Section & Base/Sand Guide
№: 21	<b>Permeable Pavement Systems</b>
№: 21	Drena™ Series
№: 22	<b>Permeable Maintenance Guide</b>
№: 22	Permeable Maintenance Guide & Cross Section
№: 24	<b>Slabs</b>
№: 24	BrükStone®
№: 24	Old Munich
№: 25	Kastle Flats Rectangle Slabs
№: 26	Bulovar® Linear Slab Series & Installation Guide for Slabs
№: 27	<b>Walls</b>
№: 27	Strassen® Wall
№: 28	Strassen® Wall II Non-Tumbled
№: 30	Strassen® Wall Fire Ring Kits
№: 32	Madera Wall
№: 34	Morteza Wall Units
№: 36	PanoMur® Wall
№: 37	<b>Retaining Wall Installation Guide</b>
№: 37	Retaining Wall Installation Guide
№: 38	Wall Engineering Request Form
№: 40	Geogrid Placement Tables
№: 43	<b>Accents</b>
№: 43	Bullnose & Step Unit
№: 44	Strassen® Wall Precast & Round Fire Pit Caps
№: 44	Precast Pillar Caps
№: 45	<b>Other Products &amp; Equipment</b>
№: 45	Pave Tech® Edge Restraint, Landscape Spikes & Adhesives/Bonds
№: 46	Geogrid - For Retaining Wall & Joint Stabilizer
№: 47	Equipment & Tools
№: 48	<b>Product Specification Ef-fortless</b>
№: 48	Efflorescence Specifications & Efflorescence Remover
№: 49	<b>Color Selection Guide</b>
№: 50	<b>Non-Stock Products</b>
№: 51	<b>Non-Stock Permeable Products</b>
№: 52	<b>Outdoor Fireplace Units</b>
№: 53	<b>Outdoor Fireplace Installation &amp; Operation</b>
№: 54	Outdoor Fireplace Layout Guides
№: 60	<b>Mathematical Formulas</b>

# TRADITIONAL PAVING STONES

## COBBLE SERIES™

STYLE		CODE	DIMENSIONS	BANDS	CUBES
<b>Cobble Half Square™</b> 3" x 6"		<b>4MC</b>	80mm x 160mm x 60mm Approximate 3 <sup>1</sup> / <sub>8</sub> " x 6 <sup>1</sup> / <sub>4</sub> " x 2 <sup>3</sup> / <sub>8</sub> " (PSF = 7.4 stones @ 28#)	8.1 SF 226# (60 stones)	56.8 SF 1590# (7 bands)
<b>Cobble Square™</b> 6" x 6"*		<b>4TC</b>	160mm x 160mm x 60mm Approximate 6 <sup>1</sup> / <sub>4</sub> " x 6 <sup>1</sup> / <sub>4</sub> " x 2 <sup>3</sup> / <sub>8</sub> " (PSF = 3.69 stones @ 28#) <i>*Available in 80mm - See Non-stock Products section.</i>	12.2 SF 342# (45 stones)	85.4 SF 2395# (7 bands)
<b>Cobble Rectangle™</b> 6" x 9"*		<b>4PC</b>	160mm x 240mm x 60mm Approximate 6 <sup>1</sup> / <sub>4</sub> " x 9 <sup>3</sup> / <sub>8</sub> " x 2 <sup>3</sup> / <sub>8</sub> " (PSF = 2.46 stones @ 28#) <i>*Available in 80mm - See Non-stock Products section.</i>	18.28 SF 512# (45 stones)	91.4 SF 2559# (5 bands)
<b>Cobble Large Square™</b> 9" x 9"		<b>4NC</b>	240mm x 240mm x 60mm Approximate 9 <sup>3</sup> / <sub>8</sub> " x 9 <sup>3</sup> / <sub>8</sub> " x 2 <sup>3</sup> / <sub>8</sub> " (PSF = 1.64 stones @ 28#)	16.5 SF 462# (27 stones)	82.5 SF 2310# (5 bands)
<b>Cobble Large Rectangle™</b> 9" x 12"		<b>4RC</b>	240mm x 320mm x 60mm Approximate 9 <sup>3</sup> / <sub>8</sub> " x 12 <sup>5</sup> / <sub>8</sub> " x 2 <sup>3</sup> / <sub>8</sub> " (PSF = 1.22 stones @ 28#)	29.5 SF 835.2# (36 stones)	88.5 SF 2506# (3 bands)
<b>Cobble™ Three Quarter</b> 4" x 6"		<b>4QC</b>	120mm x 160mm x 60mm Approximate 4 <sup>3</sup> / <sub>4</sub> " x 6 <sup>1</sup> / <sub>4</sub> " x 2 <sup>3</sup> / <sub>8</sub> " (PSF = 4.84 stones)	11.57 SF 324# (56 stones)	81 SF 2268# (7 bands)
<b>Cobble™ Large Circle</b>		<b>4LC</b>	(PSF = 4.92 stones)	6 SF 168# (30 stones)	54 SF 1512# (9 bands)
<b>Cobble™ Circle Center Pack</b>		<b>4CC</b>	Pieces needed per Circle Center: 1 Center stone 16 Small circle stones 8 Three quarter stones 3 Half squares (for rings 6 & 8) 6 CTR Packs Per Pallet		5.6 SF 160#  960#

See pages 18-20 for installation guides for traditional interlocking concrete pavements.



# Cobble Series™ Stock Colors

STOCK COLORS	CODE	STOCK COLORS	CODE	STOCK COLORS	CODE
Autumn Blend	02	Bronze Granite	27	Golden Brown*	10
Iron Range	45	Minnesota River	18	North Shore	40
Sterling Gray	05				

**For best blend results, always select from multiple cubes.**

\*Limited Stock Item

# Cobble Series™ Accent Solid Colors - Offered in 6" x 6", 6" x 9", ¾ Stone & Large Circle only.

ACCENT SOLID COLORS	CODE	ACCENT SOLID COLORS	CODE
Chamois	06	Charcoal	08

# Cobble Series™ Patterns

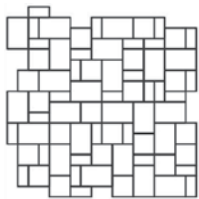

(A) 3 Piece Random  
3x6 - 16%  
6x6 - 34%  
6x9 - 50%  
Laying Ratio: 1:1:1

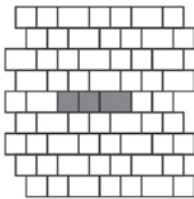

(B) Running Bond  
6x6 - 66%  
6x9 - 34%  
Laying Ratio: 2:1

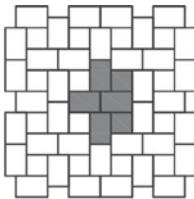

(C) Basket Weave 90°  
6x6 - 30%  
6x9 - 70%  
Laying Ratio: 2:4

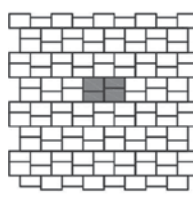

(D) Mixed Runner  
3x4 - 60%  
3x6 - 40%  
Laying Ratio: 2:2

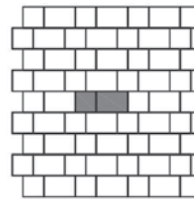

(E) Running Bond  
6x6 - 40%  
6x9 - 60%  
Laying Ratio: 1:1

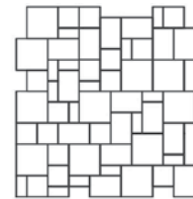

(F) 4 Piece Random  
3x6 - 10%  
6x6 - 21%  
6x9 - 27%  
9x9 - 42%  
Laying Ratio: 1:1:1:1



(G) 2 Piece  
6x9 - 33%  
9x12 - 67%  
Laying Ratio: 2:2

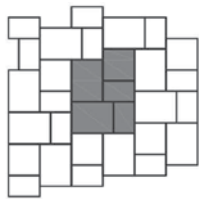

(H) 3 Piece  
6x9 - 27%  
9x9 - 20%  
9x12 - 53%  
Laying Ratio: 2:1:2

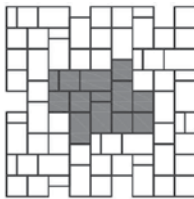

(I) 3 Piece  
3x6 - 7%  
6x6 - 50%  
6x9 - 43%  
Laying Ratio: 2:7:4

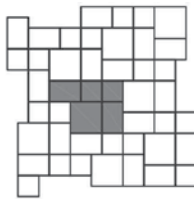

(J) 3 Piece  
6x6 - 28%  
6x9 - 41%  
9x9 - 31%  
Laying Ratio: 2:2:1

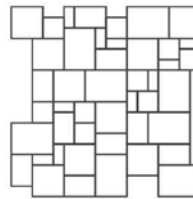

(K) 5 Piece Random  
3x6 - 6%  
6x6 - 11%  
6x9 - 18%  
9x9 - 27%  
9x12 - 38%  
Laying Ratio: 1:1:1:1:1

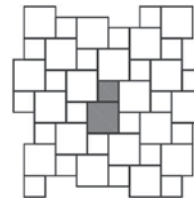

(L) 2 Piece  
6x6 - 30%  
9x9 - 70%  
Laying Ratio: 1:1

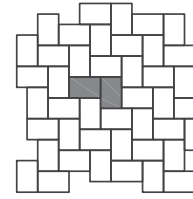

(M) 1 Piece  
6x9 - 100%

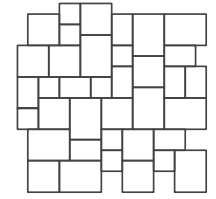

(N) 4 Piece Random  
6x6 - 13%  
6x9 - 19%  
9x9 - 29%  
9x12 - 39%  
Laying Ratio: 1:1:1:1

Need help figuring your project? Use our Stone Calculator online at [www.borgertproducts.com](http://www.borgertproducts.com).

## Circle Guide - Cobble Series™ / Cracovia

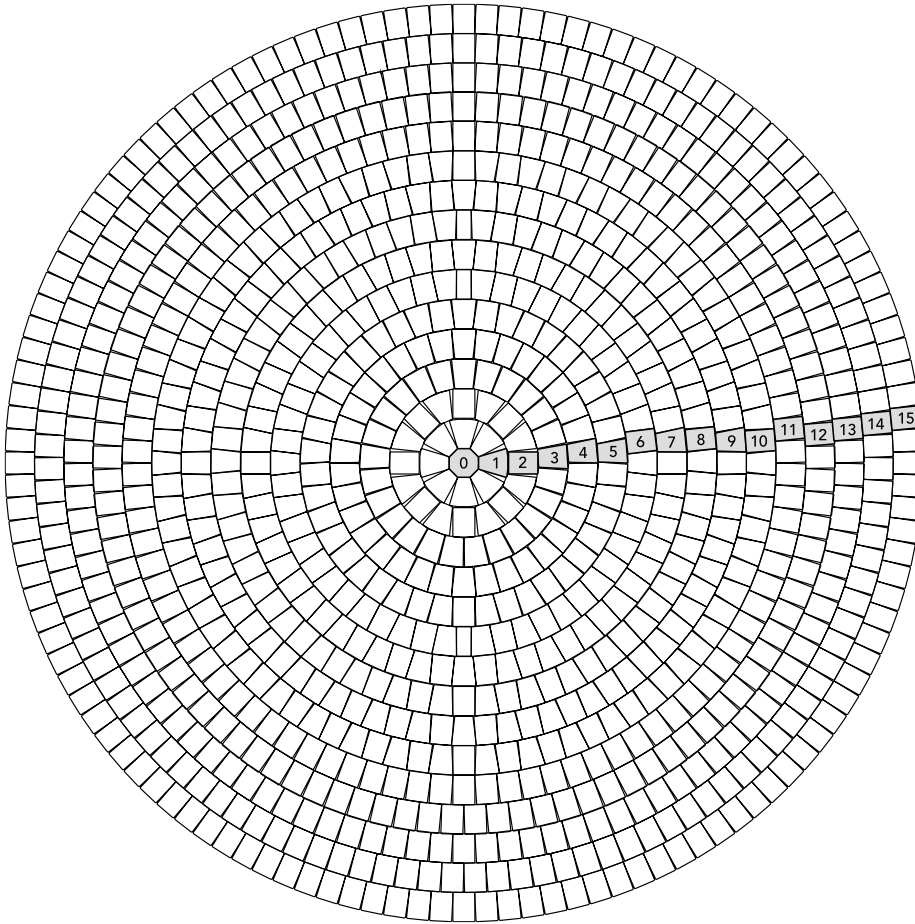

PIECES PER RING TO GET STARTED

RING	CIRCLE DIA. (CM)	CIRCLE DIA. (INCH)	CENTER CIRCLE	SMALL CIRCLE	LARGE CIRCLE	HALF SQUARE	¾ STONE/QTY. OF BANDS
0	16	6.3	1	--	--	--	--
1	49	19.3	--	8	--	--	--
2	81	31.8	--	8	--	--	8
3	113	44.6	--	--	26	--	--
4	145	57.4	--	--	34	--	--
5	178	70.1	--	--	21	--	21
6	210	82.9	--	--	26	2	24
7	243	96.5	--	--	30	--	30
8	275	108.4	--	--	34	1	33
9	307	120.7	--	--	38	--	38
10	339	133.5	--	--	42	--	42
11	371	146.2	--	--	--	--	90
12	404	159.0	--	--	--	--	97
13	436	171.7	--	--	--	--	106
14	455	184.4	--	--	--	--	115
15	501	197.1	--	--	--	--	124

You can begin your circle with your choice of diameter! The packaging of the Cobble Circle makes it easy to order just what you need. The chart above shows the total number of stones per ring. (i.e. Ring 7=96.5 inch diameter which requires 30 pieces of the Large Circle Stone and 30 pieces of the Three Quarter Stone.)

*For figuring large circles see the chart on the next page or use our Stone Calculator at [www.borgertproducts.com](http://www.borgertproducts.com) or see page 60 for mathematical formulas.*

*To go the FULL CIRCLE, see the chart on the next page, it lists the quantities and square footage of your chosen diameter. (i.e. a 14.31 foot diameter circle requires 1 center pak, 1 cube of Large Circle Stone, and 1 cube plus 2 bands of Three Quarter Stone – giving you a finished area of 163.76 square feet.)*

See pages 18-20 for installation guides for traditional interlocking concrete pavements.

## Figuring Large Circles - Cobble Series™ / Cracovia

PAVER QTY. TO THE NEAREST BAND						
RING	DIA / FT	SQ FT	CIRCLE CTR	LARGE CIRCLE	¾ STONE 81 SQ FT	TOTAL SQ FT
0-2	2.65	5.6	1 Pak	---	---	5.6
3	3.72	10.87	1 Pak	1 Band	---	11.6
4	4.78	17.95	1 Pak	2 Bands	---	17.6
5	5.84	26.79	1 Pak	3 Bands	1 Band	35.18
6	6.91	37.5	1 Pak	4 Bands	1 Band	41.18
7	8.05	50.9	1 Pak	5 Bands	2 Bands	58.76
8	9.03	64.04	1 Pak	6 Bands	2 Bands	64.76
9	10.06	79.46	1 Pak	7 Bands	3 Bands	82.34
10	11.13	97.29	1 Pak	8 Bands	4 Bands	99.88
11	12.18	116.52	1 Pak	1 Cube	5 Bands	117.45
12	13.25	137.89	1 Pak	1 Cube	1 Cube	140.6
13	14.31	160.83	1 Pak	1 Cube	1 Cube 2 Bands	163.73
14	15.37	185.54	1 Pak	1 Cube	1 Cube 4 Bands	186.87
15	16.43	212.01	1 Pak	1 Cube	2 Cubes	221.58
16	17.49	240.25	1 Pak	1 Cube	2 Cubes 2 Bands	244.72
17	18.55	270.26	1 Pak	1 Cube	2 Cubes 5 Bands	279.43
18	19.61	302.03	1 Pak	1 Cube	3 Cubes	302.57
19	20.67	335.56	1 Pak	1 Cube	3 Cubes 3 Bands	337.28
20	21.73	371	1 Pak	1 Cube	3 Cubes 6 Bands	372
21	22.79	408	1 Pak	1 Cube	4 Cubes 3 Bands	418
22	23.85	447	1 Pak	1 Cube	4 Cubes 6 Bands	453
23	24.91	487	1 Pak	1 Cube	5 Cubes 2 Bands	488
24	25.97	530	1 Pak	1 Cube	5 Cubes 6 Bands	534
25	27.03	574	1 Pak	1 Cube	6 Cubes 3 Bands	580
26	28.09	620	1 Pak	1 Cube	7 Cubes	627
27	29.15	667	1 Pak	1 Cube	7 Cubes 4 Bands	673
28	30.21	717	1 Pak	1 Cube	8 Cubes 1 Band	719
29	31.27	768	1 Pak	1 Cube	8 Cubes 6 Bands	777

## HOLLAND STONE™

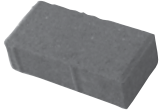
STYLE		CODE	DIMENSIONS	BANDS	CUBES
<b>Holland Stone™</b> <b>4" x 8"</b>		<b>4HS</b>	100mm x 200mm x 60mm Approximate 3 <sup>7</sup> / <sub>8</sub> " x 7 <sup>7</sup> / <sub>8</sub> " x 2 <sup>3</sup> / <sub>8</sub> " (PSF = 4.5 stones @ 28#)	15.7 SF 440# (72 stones)	94 SF 2640# (6 bands)

### Holland Stone™ Stock Colors

STOCK COLORS	CODE	STOCK COLORS	CODE	STOCK COLORS	CODE
<b>Autumn Blend</b>	<b>02</b>	<b>Bronze Granite</b>	<b>27</b>	<b>Chamois</b>	<b>06</b>
<b>Charcoal</b>	<b>08</b>	<b>Iron Range</b>	<b>45</b>	<b>Minnesota River</b>	<b>18</b>
<b>North Shore</b>	<b>40</b>	<b>Sterling Gray</b>	<b>05</b>		

*For best blend results, always select from multiple cubes.*

Need help figuring your project? Use our Stone Calculator online at [www.borgertproducts.com](http://www.borgertproducts.com).



# Holland Patterns

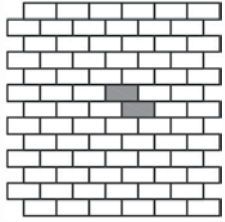

(A) Running Bond

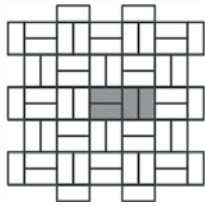

(B) Basket Weave

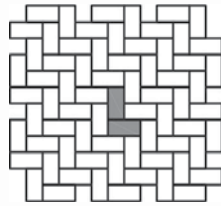

(C) Herringbone 90°

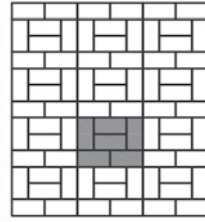

(D) Framed Parquet

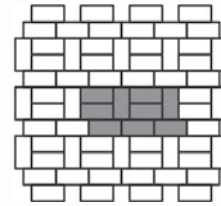

(E) Running Parquet

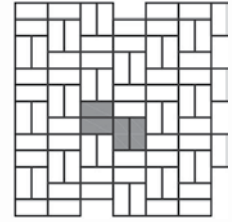

(F) Basket Weave - 2

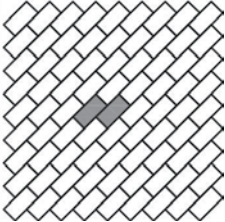

(G) Running Bond 45°

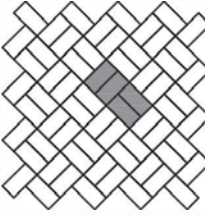

(H) Basket Weave 45°

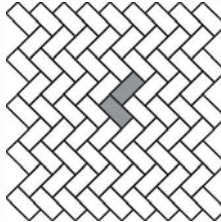

(I) Herringbone 45°

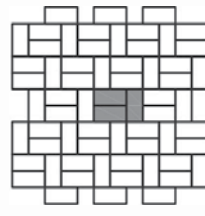

(J) Offset Parquet

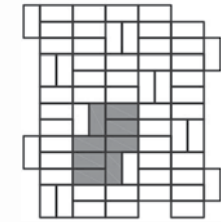

(K) Balance Parquet

See pages 18-20 for installation guides for traditional interlocking concrete pavements.

## BAVARIA II (NON-TUMBLED)

STYLE		CODE	DIMENSIONS	BANDS	CUBES
<b>Bavaria II Small Square</b> 5" x 5"		<b>4UBQ</b>	140mm x 140mm x 70mm Approximate 5½" x 5½" x 2¾" (PSF = 4.8 stones @ 31.5#)	9.98 SF 324# (48 stones)	79.8 SF 2595# (8 bands)
<b>Bavaria II Small Rectangle</b> 5" x 11"		<b>4UBH</b>	140mm x 280mm x 70mm Approximate 5½" x 11" x 2¾" (PSF = 2.4 stones @ 31.5#)	20.25 SF 659# (48 stones)	81 SF 2635# (4 bands)
<b>Bavaria II Large Square</b> 11" x 11"		<b>4UBS</b>	280mm x 280mm x 70mm Approximate 11" x 11" x 2¾" (PSF = 1.2 stones @ 31.5#)	20.25 SF 658# (24 stones)	81 SF 2632# (4 bands)
<b>Bavaria II Large Rectangle</b> 11" x 16"		<b>4UBR</b>	280mm x 420mm x 70mm Approximate 11" x 16½" x 2¾" (PSF = .80 stones @ 31.5#)	30 SF 975# (24 stones)	90 SF 2925# (3 bands)
<b>Bavaria II Three Quarter</b> 6" x 9"		<b>4UBTQ</b>	168mm x 225mm x 70mm Approximate 6½" x 9" x 2¾" (PSF = 2.4 stones @ 31.5#)	15 SF 488# (36 stones)	75 SF 2440# (5 bands)

*Note: Use protective plate during compaction.*

### Bavaria II (Non-Tumbled) Stock Colors

STOCK COLORS	CODE	STOCK COLORS	CODE	STOCK COLORS	CODE
<b>Iron Range</b>	<b>45</b>	<b>Minnesota River</b>	<b>18</b>	<b>North Shore</b>	<b>40</b>
<b>Sterling Gray</b>	<b>05</b>				

*For best blend results, always select from multiple cubes.*

### Bavaria II Accent Solid Colors - Offered in 5" x 5", 6" x 9" & 5" x 11"

ACCENT SOLID COLORS	CODE
<b>Charcoal</b>	<b>08</b>

Need help figuring your project? Use our Stone Calculator online at [www.borgertproducts.com](http://www.borgertproducts.com).

# VAVEL II™ (NON-TUMBLED)

STYLE		CODE	DIMENSIONS	BANDS	CUBES
<b>Vavel II Small Square</b> 7" x 7"		<b>4UVA</b>	178mm x 178mm x 70mm Approximate 7" x 7" x 2¾" (PSF = 2.94 stones @ 31.5#)	12.24 SF 398# (36 stones)	85.68 SF 2785# (7 bands)
<b>Vavel II Rectangle</b> 7" x 14"		<b>4UVB</b>	178mm x 356mm x 70mm Approximate 7" x 14" x 2¾" (PSF = 1.47 stones @ 31.5#)	24.48 SF 796# (36 stones)	73.44 SF 2387# (3 bands)
<b>Vavel II Large Square</b> 14" x 14"		<b>4UVC</b>	356mm x 356mm x 70mm Approximate 14" x 14" x 2¾" (PSF = .74 stones @ 31.5#)	21.76 SF 708# (16 stones)	65.28 SF 2122# (3 bands)

*Note: Use protective plate during compaction.*

## Vavel II™ (Non-Tumbled) Stock Colors

STOCK COLORS	CODE	STOCK COLORS	CODE	STOCK COLORS	CODE
<b>Iron Range</b>	<b>45</b>	<b>Minnesota River</b>	<b>18</b>	<b>North Shore</b>	<b>40</b>
<b>Sterling Gray</b>	<b>05</b>				

*For best blend results, always select from multiple cubes.*







See pages 18-20 for installation guides for traditional interlocking concrete pavements.

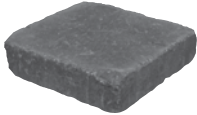

# STRASSEN® SERIES TUMBLED PAVING STONES

## STRASSEN® SERIES CRACOVIA (TUMBLED)

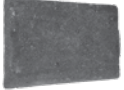
Strassen® Series Tumbled Paving Stones

STYLE		CODE	DIMENSIONS	BANDS	CUBES
<b>Cracovia Half Square</b> <b>3" x 6"</b>		<b>4TTM</b>	80mm x 160mm x 60mm Approximate 3 <sup>1</sup> / <sub>8</sub> " x 6 <sup>1</sup> / <sub>4</sub> " x 2 <sup>3</sup> / <sub>8</sub> " (PSF = 7.4 stones @ 28#)	8.1 SF 226# (60 stones)	56.8 SF 1590# (7 bands)
<b>Cracovia Square</b> <b>6" x 6"</b>		<b>4TTQ</b>	160mm x 160mm x 60mm Approximate 6 <sup>1</sup> / <sub>4</sub> " x 6 <sup>1</sup> / <sub>4</sub> " x 2 <sup>3</sup> / <sub>8</sub> " (PSF = 3.69 stones @ 28#)	12.2 SF 342# (45 stones)	85.4 SF 2395# (7 bands)
<b>Cracovia Rectangle</b> <b>6" x 9"</b>		<b>4TTP</b>	160mm x 240mm x 60mm Approximate 6 <sup>1</sup> / <sub>4</sub> " x 9 <sup>3</sup> / <sub>8</sub> " x 2 <sup>3</sup> / <sub>8</sub> " (PSF = 2.46 stones @ 28#)	18.28 SF 512# (45 stones)	91.4 SF 2559# (5 bands)
<b>Cracovia Large Square</b> <b>9" x 9"</b>		<b>4TTN</b>	240mm x 240mm x 60mm Approximate 9 <sup>3</sup> / <sub>8</sub> " x 9 <sup>3</sup> / <sub>8</sub> " x 2 <sup>3</sup> / <sub>8</sub> " (PSF = 1.64 stones @ 28#)	16.5 SF 462# (27 stones)	82.5 SF 2310# (5 bands)
<b>Cracovia Three Quarter</b> <b>4" x 6"</b>		<b>4TQC</b>	120mm x 160mm x 60mm Approximate 4 <sup>3</sup> / <sub>4</sub> " x 6 <sup>1</sup> / <sub>4</sub> " x 2 <sup>3</sup> / <sub>8</sub> " (PSF = 4.84 stones)	11.57 SF 324# (56 stones)	81 SF 2268# (7 bands)
<b>Cracovia Large Circle</b>		<b>4TLC</b>	(PSF = 4.92 stones) <i>- Same length as the three qtr. Cracovia, for radius see circle diagram.</i>	6 SF 168# (30 stones)	54 SF 1512# (9 bands)
<b>Cracovia Circle</b> <b>Center Pack</b>		<b>4TCC</b>	Pieces needed per Circle Center: 1 Center stone 16 Small circle stones 8 Three quarter stones 3 Half squares (for rings 6 & 8) 6 CTR Packs Per Pallet		5.6 SF 160#  960#

**Note: Cracovia is packaged the way it is to be laid. DO NOT flip pavers, spacer bars must offset during install.**

See page 6 for Circle Diagram

### Strassen® Series Cracovia (Tumbled) Stock Colors

STOCK COLORS	CODE	STOCK COLORS	CODE	STOCK COLORS	CODE
<b>Grand Canyon</b>	<b>44</b>	<b>Iron Range</b>	<b>45</b>	<b>Mesa</b>	<b>43</b>
<b>Minnesota River</b>	<b>18</b>	<b>North Shore</b>	<b>40</b>	<b>Sterling Gray</b>	<b>05</b>

**For best blend results, always select from multiple cubes.**

### Strassen® Series Cracovia Accent Solid Colors - Offered in 4" x 6" & Large Circle only.

ACCENT SOLID COLORS	CODE	ACCENT SOLID COLORS	CODE
<b>Chamois</b>	<b>06</b>	<b>Charcoal</b>	<b>08</b>

**For best blend results, always select from multiple cubes.**

# Strassen® Series Cracovia (Tumbled) Patterns

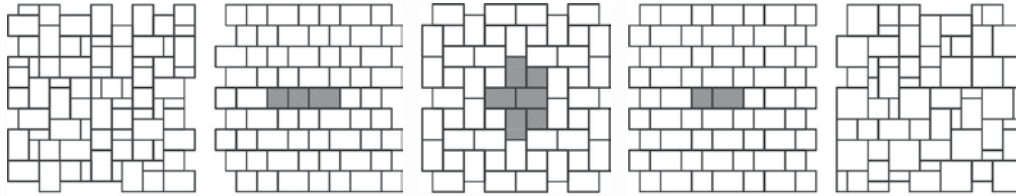

(A) 3 Piece Random  
3x6 - 16%  
6x6 - 34%  
6x9 - 50%  
Laying Ratio: 1:1:1

(B) Running Bond  
6x6 - 66%  
6x9 - 34%  
Laying Ratio: 2:1

(C) Basket Weave 90°  
6x6 - 30%  
6x9 - 70%  
Laying Ratio: 2:4

(D) Running Bond  
6x6 - 40%  
6x9 - 60%  
Laying Ratio: 1:1

(E) 4 Piece Random  
3x6 - 10%  
6x6 - 21%  
6x9 - 27%  
9x9 - 42%  
Laying Ratio: 1:1:1:1

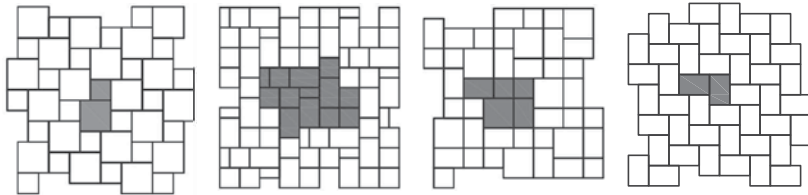

(F) 2 Piece  
6x6 - 30%  
9x9 - 70%  
Laying Ratio: 1:1



(I) 3 Piece  
3x6 - 7%  
6x6 - 50%  
6x9 - 43%  
Laying Ratio: 2:7:4

(J) 3 Piece  
6x6 - 28%  
6x9 - 41%  
9x9 - 31%  
Laying Ratio: 2:2:1

(M) 1 Piece  
6x9 - 100%

For circles see Cobble/Cracovia Circle page 6.

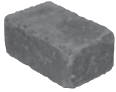
## STRASSEN® SERIES CLASSIC (TUMBLED)

STYLE		CODE	DIMENSIONS	BANDS	CUBES
<b>Classic Half Rectangle</b> <b>4" x 6"</b>		<b>4SM</b>	104mm x 173mm x 70mm Approximate 4 <sup>1</sup> / <sub>4</sub> " x 6 <sup>3</sup> / <sub>4</sub> " x 2 <sup>3</sup> / <sub>4</sub> " (PSF = 5.06 stones @ 31.5#)	4.75 SF 155# (24 stones)	52.2 SF 1696# (11 bands)
<b>Classic Rectangle</b> <b>6" x 8"</b>		<b>4ST</b>	173mm x 208mm x 70mm Approximate 6 <sup>3</sup> / <sub>4</sub> " x 8 <sup>1</sup> / <sub>4</sub> " x 2 <sup>3</sup> / <sub>4</sub> " (PSF = 2.53 stones @ 31.5#)	9.49 SF 309# (24 stones)	66.4 SF 2160# (7 bands)
<b>Classic Large Rectangle</b> <b>8" x 13"</b>		<b>4SP</b>	208mm x 348mm x 70mm Approximate 8 <sup>1</sup> / <sub>4</sub> " x 13 <sup>5</sup> / <sub>8</sub> " x 2 <sup>3</sup> / <sub>4</sub> " (PSF = 1.28 stones @ 31.5#)	9.38 SF 305# (12 stones)	56.3 SF 1830# (6 bands)

**ATTENTION: CLASSIC PAVERS DO NOT HAVE SPACE BARS. LAY PAVERS LOOSELY WITH 1/16" JOINT TO ENABLE ADJUSTMENTS TO MAINTAIN STRAIGHT LINES & MINIMIZE ADDITIONAL CHIPPING OVER THE LIFE OF THE PAVEMENT.**

**8" x 13" and 4" x 6" need to run lengthwise perpendicular to the 6" x 8".**

## Strassen® Series Classic Stock Colors

ACCENT SOLID COLORS	CODE	ACCENT SOLID COLORS	CODE	ACCENT SOLID COLORS	CODE
<b>Boulder Blend</b>	<b>37</b>	<b>Minnesota River</b>	<b>18</b>	<b>Sterling Gray</b>	<b>05</b>

For best blend results, always select from multiple cubes.

\*Strassen Classic is a minimal stock item.

# Strassen® Series Classic Patterns

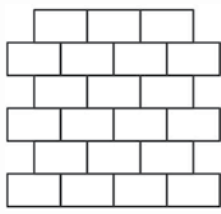

(A) 1 Piece  
8x13 - 100%

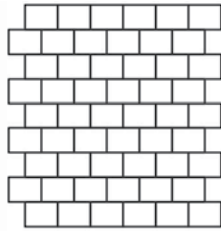

(B) 1 Piece  
6x8 - 100%

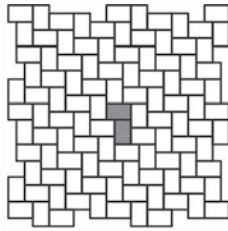

(C) 1 Piece  
4x6 - 100%

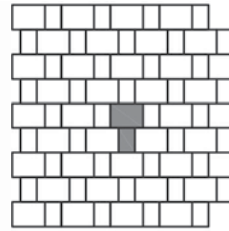

(D) 2 Piece  
4x6 - 34%  
6x8 - 66%  
Laying Ratio: 1:1

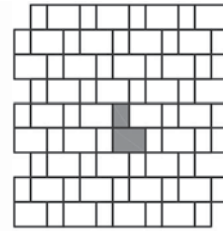

(E) 2 Piece  
4x6 - 34%  
6x8 - 66%  
Laying Ratio: 1:1

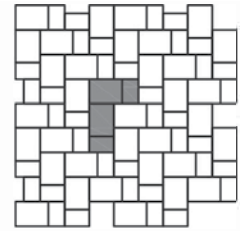

(F) 2 Piece  
4x6 - 34%  
6x8 - 66%  
Laying Ratio: 2:2

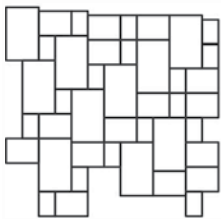

(G) 3 Piece Random  
4x6 - 15%  
6x8 - 28%  
8x13 - 57%  
Laying Ratio: 1:1:1

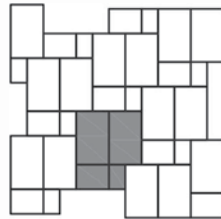

(H) 3 Piece  
4x6 - 9%  
6x8 - 17%  
8x13 - 74%  
Laying Ratio: 1:1:2

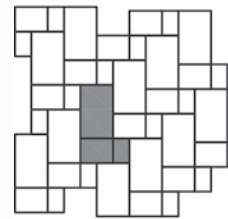

(I) 3 Piece  
4x6 - 15%  
6x8 - 28%  
8x13 - 57%  
Laying Ratio: 1:1:1

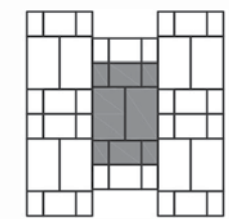

(J) 3 Piece  
4x6 - 24%  
6x8 - 24%  
8x13 - 52%  
Laying Ratio: 4:2:2

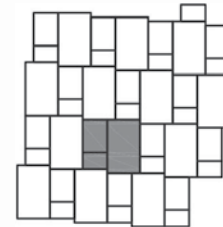

(K) 3 Piece  
4x6 - 15%  
6x8 - 28%  
8x13 - 57%  
Laying Ratio: 1:1:1

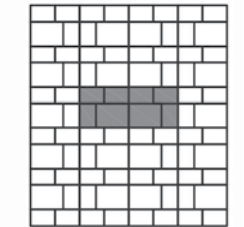

(L) 2 Piece  
4x6 - 60%  
6x8 - 40%  
Laying Ratio: 6:2

Need help figuring your project? Use our Stone Calculator online at [www.borgertproducts.com](http://www.borgertproducts.com).



# NOTES

Notes

A large grid of graph paper for taking notes, consisting of 20 columns and 30 rows of small squares.

# STRASSEN® SERIES BAVARIA (TUMBLLED)

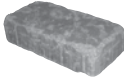
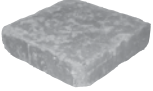
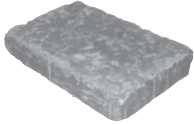
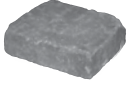
STYLE		CODE	DIMENSIONS	BANDS	CUBES
<b>Bavaria Small Square</b> <b>5" x 5"</b>		<b>4BQ</b>	140mm x 140mm x 70mm Approximate 5½" x 5½" x 2¾" (PSF = 4.8 stones @ 31.5#)	6.25 SF 203# (30 stones)	50.0 SF 1625# (8 bands)
<b>Bavaria Small Rectangle</b> <b>5" x 11"</b>		<b>4BH</b>	140mm x 280mm x 70mm Approximate 5½" x 11" x 2¾" (PSF = 2.4 stones @ 31.5#)	7.56 SF 246# (18 stones)	60.48 SF 1965# (8 bands)
<b>Bavaria Large Square</b> <b>11" x 11"</b>		<b>4BS</b>	280mm x 280mm x 70mm Approximate 11" x 11" x 2¾" (PSF = 1.2 stones @ 31.5#)	15.12 SF 491# (18 stones)	60.48 SF 1965# (4 bands)
<b>Bavaria Large Rectangle</b> <b>11" x 16"</b>		<b>4BR</b>	280mm x 420mm x 70mm Approximate 11" x 16½" x 2¾" (PSF = .80 stones @ 31.5#)	22.5 SF 731# (18 stones)	67.5 SF 2195# (3 bands)
<b>Bavaria Three Quarter</b> <b>6" x 9"</b>		<b>4BTQ</b>	168mm x 225mm x 70mm Approximate 6½" x 8¾" x 2¾" (PSF = 2.4 stones @ 31.5#)	7.5 SF 244# (18 stones)	52.5 SF 1706# (7 bands)

## Strassen® Series Bavaria Stock Colors

STOCK COLORS	CODE	STOCK COLORS	CODE	STOCK COLORS	CODE
<b>Iron Range</b>	<b>45</b>	<b>Minnesota River</b>	<b>18</b>	<b>North Shore</b>	<b>40</b>
<b>Sterling Gray</b>	<b>05</b>				

*For best blend results, always select from multiple cubes.*

## Strassen® Bavaria Accent Solid Colors - For 5" x 5", 6" x 9" & 5" x 11"

ACCENT SOLID COLORS	CODE
<b>Charcoal</b>	<b>08</b>

*For best blend results, always select from multiple cubes.*

Need help figuring your project? Use our Stone Calculator online at [www.borgertproducts.com](http://www.borgertproducts.com).

# Strassen® Series Bavaria and Bavaria II Patterns

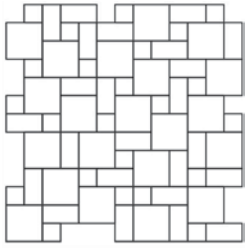

(A) 3 Piece Random  
5x5 - 16%  
5x11 - 34%  
11x11 - 50%  
Laying Ratio: 1:1:1

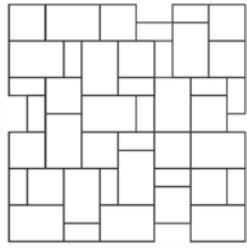

(B) 3 Piece Random  
5x11 - 16%  
11x11 - 34%  
11x16 - 50%  
Laying Ratio: 1:1:1

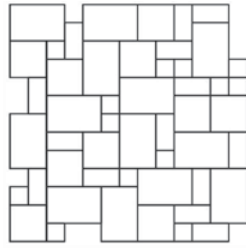

(C) 4 Piece Random  
5x5 - 7%  
5x11 - 15%  
11x11 - 31%  
11x16 - 47%  
Laying Ratio: 1:1:1:1

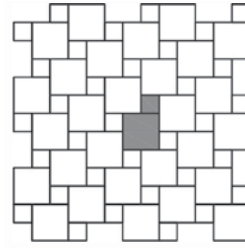

(D) 2 Piece  
5x5 - 20%  
11x11 - 80%  
Laying Ratio: 1:1

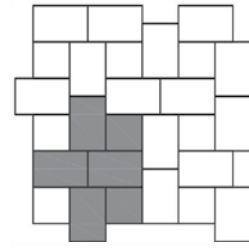

(E) 2 Piece  
11x11 - 30%  
11x16 - 70%  
Laying Ratio: 2:4

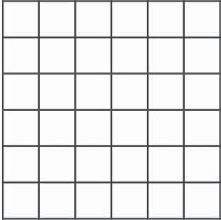

(F) 1 Piece  
11x11 - 100%

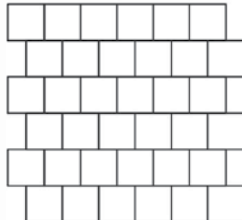

(G) 1 Piece  
11x11 - 100%

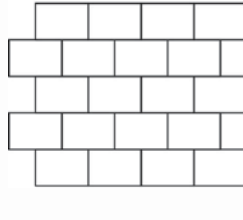

(H) 1 Piece  
11x16 - 100%

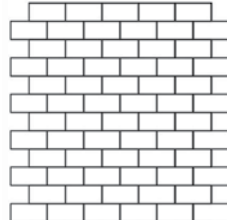

(I) 1 Piece  
5x11 - 100%

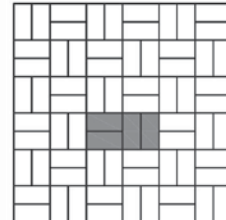

(J) 1 Piece  
5x11 - 100%

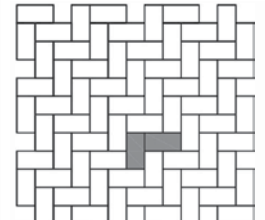

(K) 1 Piece  
5x11 - 100%

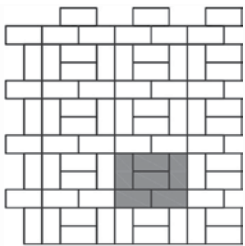

(L) 1 Piece  
5x11 - 100%

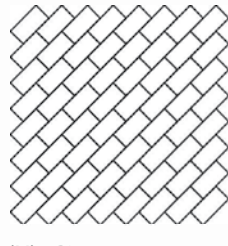

(M) 1 Piece  
5x11 - 100%

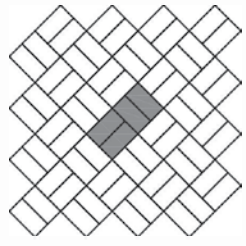

(N) 1 Piece  
5x16 - 100%

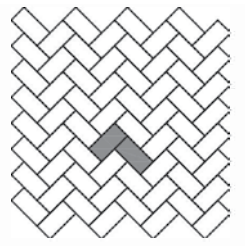

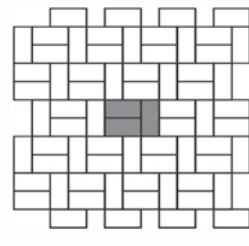

(O) 1 Piece  
5x11 - 100%



(P) 1 Piece  
5x11 - 100%

See pages 18-20 for installation guides for traditional interlocking concrete pavements.

# STRASSEN® SERIES VAVEL STONE (TUMBLED)

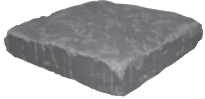
STYLE		CODE	DIMENSIONS	BANDS	CUBES
<b>Vavel Small Square</b> 7" x 7"		<b>4VA</b>	178mm x 178mm x 70mm Approximate 7" x 7" x 2¾" (PSF = 2.94 stones @ 31.5#)	8.16 SF 265# (24 stones)	48.96 SF 1591# (6 bands)
<b>Vavel Rectangle</b> 7" x 14"		<b>4VB</b>	178mm x 356mm x 70mm Approximate 7" x 14" x 2¾" (PSF = 1.47 stones @ 31.5#)	21.76 SF 707# (32 stones)	65.28 SF 2122# (3 bands)
<b>Vavel Large Square</b> 14" x 14"		<b>4VC</b>	356mm x 356mm x 70mm Approximate 14" x 14" x 2¾" (PSF = .74 stones @ 31.5#)	21.76 SF 707# (16 stones)	65.28 SF 2122# (3 bands)

*Note: Use protective plate during compaction.*

## Strassen® Series Vavel Stone Stock Colors

STOCK COLORS	CODE	STOCK COLORS	CODE	STOCK COLORS	CODE
<b>Iron Range</b>	<b>45</b>	<b>Minnesota River</b>	<b>18</b>	<b>North Shore</b>	<b>40</b>
<b>Sterling Gray</b>	<b>05</b>				

*For best blend results, always select from multiple cubes.*

## Strassen® Series Vavel Stone and Vavel Stone II Patterns

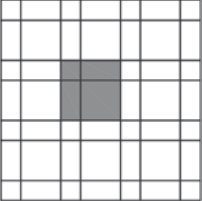
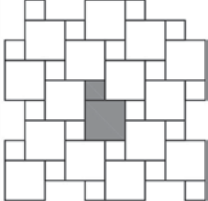
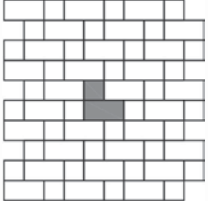
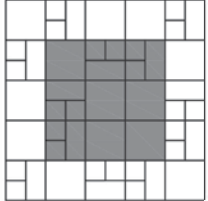
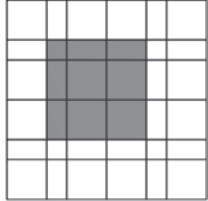
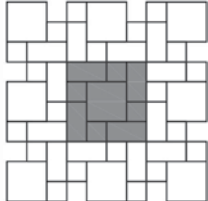
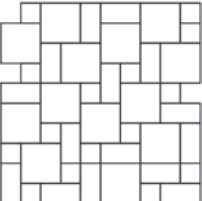
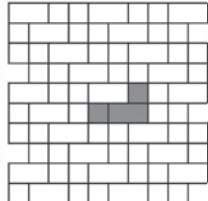
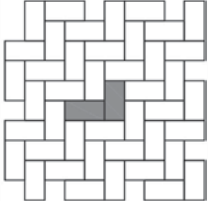
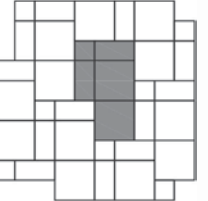
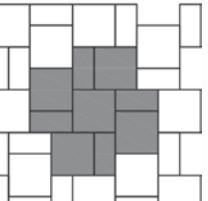
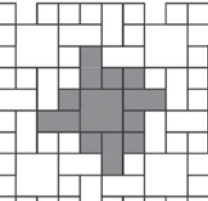
					
(A) 3 Piece 7x7 - 10% 7x14 - 45% 14x14 - 45% Laying Ratio: 1:2:1	(B) 2 Piece 7x7 - 20% 14x14 - 80% Laying Ratio: 1:1	(C) 2 Piece 7x7 - 34% 7x14 - 66% Laying Ratio: 1:1	(D) 3 Piece 7x7 - 22% 7x14 - 22% 14x14 - 56% Laying Ratio: 8:4:5	(E) 3 Piece 7x7 - 3% 7x14 - 32% 14x14 - 64% Laying Ratio: 1:4:4	(F) 3 Piece 7x7 - 25% 7x14 - 50% 14x14 - 25% Laying Ratio: 4:4:1
					
(G) 3 Piece Random 7x7 - 14% 7x14 - 29% 14x14 - 57% Laying Ratio: 1:1:1	(H) 2 Piece 7x7 - 50% 7x14 - 50% Laying Ratio: 2:1	(I) 1 Piece 7x14 - 100%	(J) 3 Piece 7x7 - 8% 7x14 - 31% 14x14 - 61% Laying Ratio: 1:2:2	(K) 2 Piece 7x14 - 29% 14x14 - 71% Laying Ratio: 4:5	(L) 3 Piece 7x7 - 33% 7x14 - 45% 14x14 - 22% Laying Ratio: 6:4:1

Need help figuring your project? Use our Stone Calculator online at [www.borgertproducts.com](http://www.borgertproducts.com).

# INSTALLATION GUIDES FOR ICP

## INSTALLATION GUIDE FOR TRADITIONAL INTERLOCKING CONCRETE PAVEMENTS

### Tools Needed:

- Wooden stakes
- Wide blade masons chisel
- Masons string (twine)
- Stiff bristle street broom
- 3lb. - 5lb. rubber hammer
- Hard tooth garden rake
- Chalk line
- 25' ft. measure tape
- 1" diameter sand screed guides (pipe, wood, etc.)
- 6' - 8' ft. 2" x 4" or 2" x 6"
- Small pry bar
- 4 ft. Level
- Wheelbarrow
- Flat shovel

### EQUIPMENT:

- 3hp to 5hp plate compactor (not a jumping jack)
- Mason diamond saw
- Block/Paver splitter

### INSTALLATION:

First measure area you intend to pave. Determine square footage by multiplying (length x width = square footage) add 5% for breakage and cutting. Measure lineal feet of open edges, those not up against a permanent structure such as a house, etc. This will indicate lineal footage of **PAVE EDGE** required. Draw a plan on a piece of paper showing all important dimensions. Take this plan to your supplier so that they can help you determine the proper amount of materials needed to complete your project.

Using the 3-4-5 triangle method to determine a perpendicular line, measure parallel lines from the perpendicular line to establish a boundary. Place stakes every 4 feet to 6 feet and at corners. These stakes should be 8" outside of the planned edge of the pavers.

**NOTE: You can check to make sure an area is square by making sure both sets of cross corners measure the exact same distance.**

### EXCAVATION:

**NOTE: Before any digging call your local utility companies to locate any underground lines.**

Using a flat shovel cut evenly to remove sod/dirt to a depth of at least 7" (18cm) to allow room for 2 $\frac{3}{8}$ " (6cm) paver, compacted sand, minimum of 4" (10cm) compacted crushed stone base (more if soil is very soft). If the house is of new construction there might be potential for settling next to the foundation. We suggest you increase base thickness to 6" (15cm) or a total excavation of 9" (23cm) within 2 feet (1 meter) of new foundation. Excavation should be 6" (15cm) wider on sides where **PAVE EDGE** edge restraint is to be used.

### BASE PREPARATION:

This is very important. The more time and effort you put into the preparation of the base, the better the project and the longer it will last. Use either  $\frac{3}{4}$ " (19mm) or  $\frac{1}{2}$ " (13mm) graded base material that includes sizes down to fine dust. This material is easier to compact and will give a tight, close-knit surface of compaction.

### METHOD OF COMPACTION:

First, run your plate compactor over the excavated soil. (Make sure no soil gets stuck to the bottom of the plate compactor). Each pass should overlap the previous one by about 4". Now spread your gravel base material out evenly in about 2" layers.

If material is dry and dusty use a garden hose to thoroughly wet it down, this helps make the gravel faster to compact and easier to rake. Start around the outer perimeter with the plate compactor and again overlap each pass about 4" working towards the center. You should make at least two complete passes for each layer. Use the hard tooth garden rake to smooth out any unevenness.

When finished with the base it should be very smooth and flat. If you were to put a straight edge flat on the surface there should be no more than a  $\frac{1}{4}$ " (6mm) maximum gap anywhere along the straight edge and the base.

### SLOPE AND GRADE:

Slope and Grade are important to ensure proper run-off. It is best to plan a  $\frac{1}{4}$ " (6mm) per foot drop, but try not to exceed  $\frac{1}{2}$ " (12mm) per foot.

*See typical cross section on page 20.*

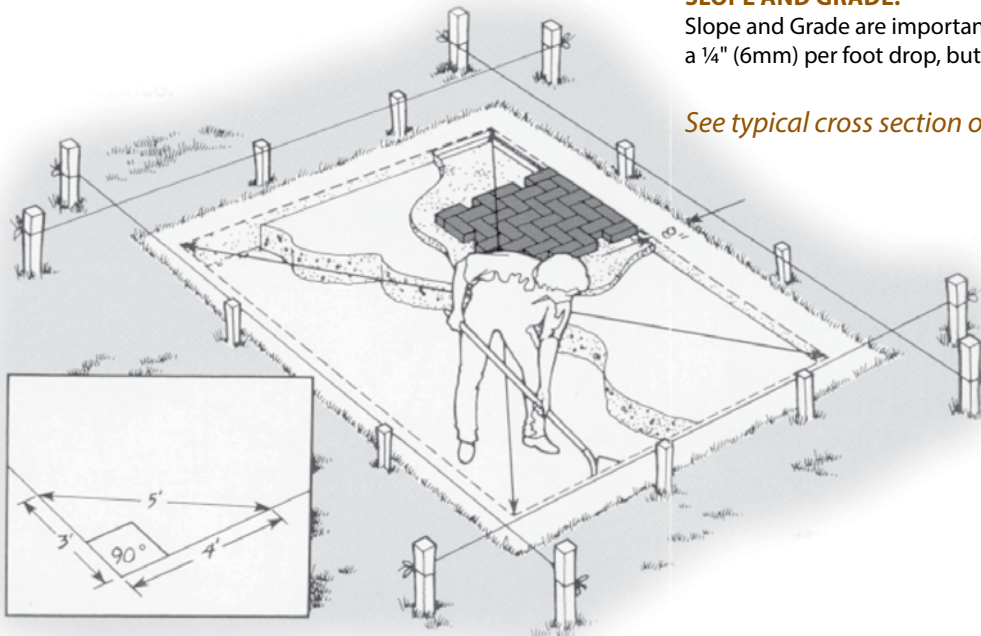



## SAND SETTING BED - ASTM C33:

**NOTE: It is important to keep your sand dry and covered in case of rain.**

Do not attempt to level any area or surface irregularities with the sand. This will result in an uneven surface and unwanted settling.

Lay your screed guides (1" (25mm) electrical conduit, 1" strips of wood or other suitable rigid 1" guide) 4' ft. to 6' ft. apart and parallel. Work from side to side with your screed guides, screed a 10' section of sand. You will use the 6' ft. to 8' ft. 2" x 6" to loosely spread the sand and to strike off any excess.

**DO NOT** walk on or work from your screeded sand. Do not worry about voids that screed guides have left after you have removed them. You will lightly fill them with sand and trowel them smooth as you are laying the pavers.

## LAYING THE PAVERS:

*(Instructions for small areas only)*

Starting from a permanent edge such as a house, driveway, or even a piece of **PAVE EDGE**, lay your first paver starting from either side. (As you start laying Pavers, work from right to left, then left to right and so on, one row of pavers at a time.) Set the pavers lightly onto the sand, never press them or hammer them in. Be sure to allow 6" (15cm) to **PAVE EDGE** on the open sides later. If you are starting with **PAVE EDGE** as a starting point (see pave edge installation below), run a string line across the front of the laying edge about every 4' ft.

If there are some Pavers lagging behind, go about three rows of Pavers back and using a small pry bar, wedge between the Pavers and pry the Pavers forward until they are in line again.

Do not worry too much about gaps at this point, they will even out during tamping later. Many different laying patterns are possible, but herringbone provides the best surface interlock.

Set the pavers hand tight, but **DO NOT** use a hammer to adjust the pavers or set them. If you are doing the project over a couple of days, cover the entire area with plastic overnight if rain is expected. Do not lay Pavers over the 6" (15cm) extended base area where **PAVE EDGE** is to be set later.

## CUTTING THE PAVERS:

You will need to cut pavers if you have to go around a post or come up against an existing structure or where a radius is desired.

You do not need to cut (except maybe 1/2" stones) on sides where **PAVE EDGE** is installed. Mark any stones to be cut with a crayon or chalk and allow for up to a 1/4" (6mm) gap between the stone and the edge. This will be filled with sand later. You should use either a diamond blade mason saw or a paver splitter.

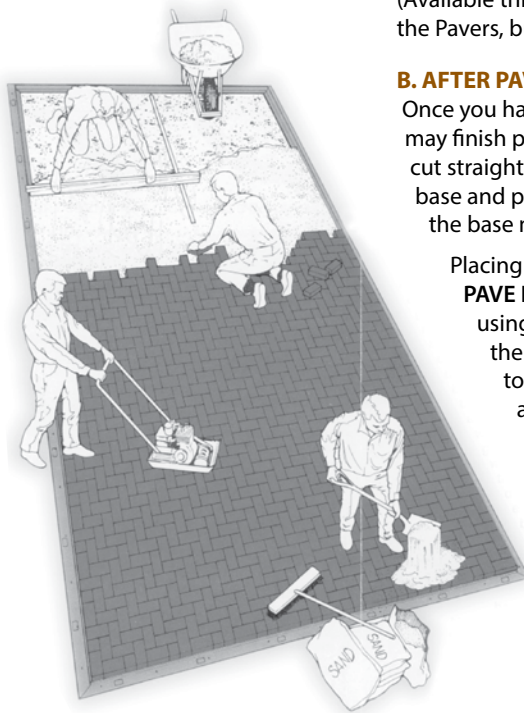

## PAVE EDGE Installation

### A. BEFORE SAND SCREEDING

Snap chalkline on base material before you screed sand if you are going to start laying your pavers from a **PAVE EDGE** line first. Spike edging so that the chalk line remains visible. Spike every two feet with 10" (25cm) x 3/8" (9mm) diameter steel landscape spike. (Available through your paver supplier.) **PAVE EDGE** not only holds the Pavers, but the sand as well.

### B. AFTER PAVERS HAVE BEEN LAID

Once you have completed the laying of pavers on the sand you may finish placing the **PAVE EDGE** spikes. First, using a trowel, cut straight down the side of the pavers into the sand down to the base and pull back the sand. Be careful not to scrape up the base material.

Placing the edging flat onto the base, push **PAVE EDGE** frost heave lip under the sand, using a hammer to tap against the back of the **PAVE EDGE** until the edging is tight to the pavers. Now, spike the edging approximately every two feet. Pound the spikes in until the head of the spike is touching the edging.



### C. USE PAVE EDGE RIGID FOR STRAIGHT AREAS

### D. USE PAVE EDGE FLEXIBLE FOR CURVED AREAS THE FINAL STEP

Assuming that you have now laid all your pavers, placed and spiked all your **PAVE EDGE**, you are ready for the last step.

**NOTE:** During this step the pavers will settle in about 1/4" lower during compaction (only if 1" loose screeded sand has been used). This should be their final height.

1. Sweep any debris or loose sand off of the Pavers.
2. Using a vibratory plate compactor, 3 HP to 5 HP, you should make at least two passes over the pavers. Starting around the perimeter and working inward, overlap each pass 2" to 4" inches. Make the second pass at a 45° degree angle to your first. The first pass of the compactor will accomplish the following:
  - will level the Pavers
  - compact the sand bedding
  - force sand up into the joint
3. Repeat Step 2 if pavers are not yet level and flat.
4. Using a **DRY** medium or coarse washed sand for the joints, spread a thin layer of the jointing sand over the surface. Use a stiff bristle street broom and sweep back and forth over the entire pavement until sand has stopped filling into joints.
5. Now, alternating between compacting and sweeping, continue to work the material into the joint. If when you make a pass with the plate compactor and no more joints open up, you are then finished.
6. Sweep off all excess sand and backfill edges with top soil and sod or seed. (Be sure to water freshly seeded or sodded areas regularly.)

**Congratulations!** You have now installed a high quality pavement for your patio or walkway. Yours to enjoy for a long time to come. For maintenance see [icpi.org](http://icpi.org).

Need help figuring your project? Use our Stone Calculator online at [www.borgertproducts.com](http://www.borgertproducts.com).

# TYPICAL CROSS SECTION OF TRADITIONAL INTERLOCKING CONCRETE PAVEMENTS (ICP)

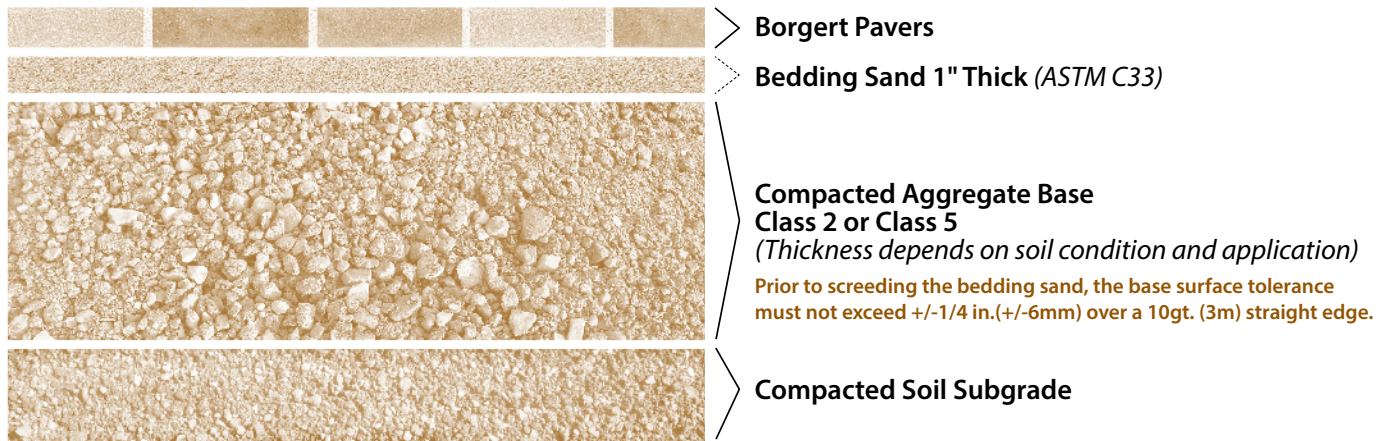

A proper base is required and is essential no matter what type of pavement you are building. The only thing different with interlocking concrete paving stones is that you need an edge restraint and one-inch setting bed to place the pavers on, then you compact the pavers into the sand, which creates the initial "lock" of the system.

After initial compaction inspect for any broken pavers, replace and put sand on top of the pavers and continue compacting and sweeping until the sand is worked into the joints.

## BASE/SAND GUIDE

ITEM	CODE
Class 2 Granite Base	5MB00
Granite Sand	5MC10
Washed Sand - C33	5MC00



ITEM	CODE
1/4" Chips (for Permeable Pavement) 2,000 lb. Sack	5CC01
Granite Sand 2,000 lb. Sack	5MC01



## How to Figure Sand & Base Needed

### 1. Convert all measurements to feet:

1" = .0833'   2" = .1666'   3" = .25'   4" = .3333'   5" = .4166'   6" = .50'  
 7" = .5833'   8" = .6666'   9" = .75'   10" = .8333'   11" = .9166'   12" = 1'

### 2. Length x Width x Depth = Cubic Feet   3. Cubic feet divided by 27 = Cubic Yards needed for project.

**EXAMPLE Base and sand for a 20' x 20' area with a 6" base and 1" of sand cushion is as follows:**

6" Base: 20 x 20 x .50 = 200 cubic feet / 200 divided by 27 = 7.40 yards base material needed.

1" Sand: 20 x 20 x .0833 = 33.33 cubic feet / 33.33 divided by 27 = 1.23 yards of sand needed.

Need help figuring your project? Use our Stone Calculator online at [www.borgertproducts.com](http://www.borgertproducts.com).

# PERMEABLE PAVEMENT SYSTEMS

## DRENA™ SERIES PERMEABLE PAVEMENTS

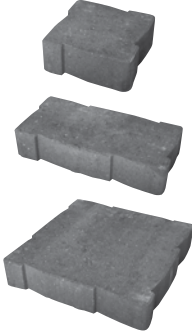
STYLE		CODE	DIMENSIONS	CUBES
<b>DrenaPave™</b> 80mm Thickness		<b>4FP</b>	125mm x 250mm x 80mm Approximate 5" x 10" x 3 1/8" (PSF = 2.96 stones @ 35.5#) (MINIMUM STOCK Item - LEAD TIME REQUIRED)  - AVAILABLE FOR MACHINE LAY - SEE PAGE 51 - NOT SOLD BY THE BAND	81 SF 2876# (240 pcs)
<b>DrenaMontage™</b> 60mm Thickness		<b>4FPM</b>	Package includes: 3 sizes mixed: Small Square - 150mm x 150mm x 60mm Approximate 5 7/8" x 5 7/8" x 2 3/8" Large Rectangle - 150mm x 300mm x 60mm Approximate 5 7/8" x 11 7/8" x 2 3/8" Large Square - 300mm x 300mm x 60mm Approximate 11 7/8" x 11 7/8" x 2 3/8"  - NOT SOLD BY THE BAND	92.04 SF 2557# (15.34 SF per layer)



### Drena™ Series Stock Colors

STOCK COLORS	CODE	STOCK COLORS	CODE
<b>Minnesota River</b>	<b>18</b>	<b>Sterling Gray</b>	<b>05</b>

**For best blend results, always select from multiple cubes.**

**Note: Permeable pavement requires maintenance. (see page 22) Refer to [www.icpi.org](http://www.icpi.org) for permeable maintenance.**

**Note: Permeable pavement is a stormwater management system that requires engineering. See page 22 for the cross section drawing.**

## BORDER CHOICE FOR 8CM PRODUCTS

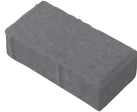
STYLE		CODE	DIMENSIONS	CUBES
<b>Holland Stone™</b> 80mm		<b>4HE</b>	100mm x 200mm x 80mm Approximate 3 7/8" x 7 7/8" x 3 1/8" (PSF = 4.5 stones @ 35.5#) <b>For bordering with permeable DrenaPave™</b> (MINIMUM STOCK Item - LEAD TIME REQUIRED)  - NOT SOLD BY THE BAND	64 SF 2272# (288 pcs)

### Holland Stone™ Stock Colors

STOCK COLORS	CODE
<b>Charcoal</b>	<b>08</b>

For additional permeable options, see Non-stock Permeable Products on page 51.



# PERMEABLE MAINTENANCE GUIDE

## PERMEABLE CROSS SECTION (PICP)

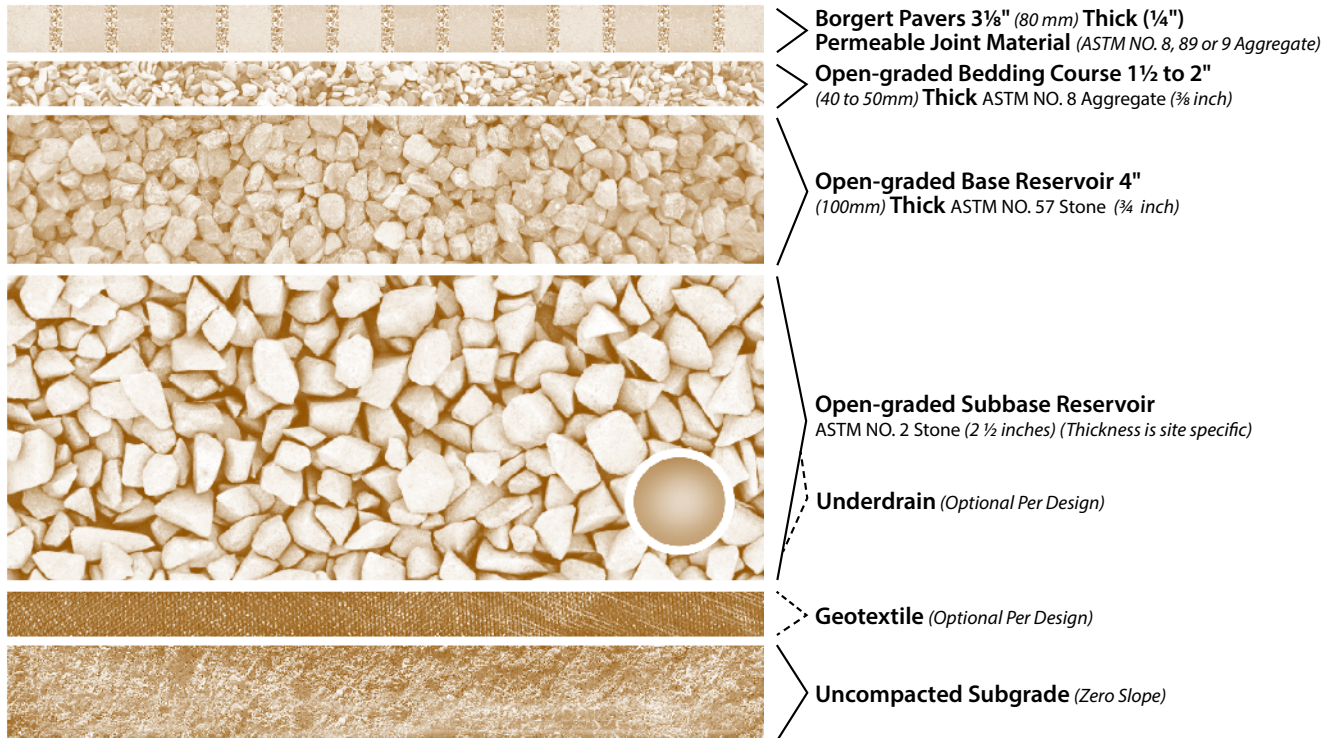

To be designed by a Professional Engineer according to state DOT specifications

**PICP IS SITE SPECIFIC - CONSULT AN ENGINEER**

## BORGERT PICP MAINTENANCE RECOMMENDATIONS:

Borgert's Permeable Interlocking Concrete Pavement (PICP) System is a stormwater management technique to prevent harmful runoff from entering waterways. The system is considered 100% permeable and can be designed to capture a certain design storm's precipitation and infiltrate the water back into the ground or exfiltrate out through a pipe.

The system traps a high amount of pollutants and debris in the joints, preventing it from entering waterways or drinking water supplies. This does lead to the need to maintain the system.

This document provides an overview of maintenance techniques and guidelines depending on the type of project.

Lack of maintenance will cause product failure and voids any warranties.

## CONSIDERATIONS:

**Tolerance:** A conservative initial infiltration rate of the system is 300 inches/hour. Slight clogging of the system can still allow infiltration rates to accommodate the design storm.

**Contributing Areas:** If there is a high ratio of run-on to surface area of the system, greater and more frequent maintenance will be required.

**Slope:** If the system itself is sloped, the area must be large enough to capture the design storm on the system without running off. Current estimates from research indicate a slope less than 10% will not impact the infiltration rate.

**Ice:** If the goal is to eliminate the formation of ice, the snow needs to be removed promptly and the systems must remain unclogged.

## PREVENTATIVE MAINTENANCE:

**Joint Material:** Keep the joints filled with the proper material, check and refill every 6 months. The fill should reach the top of the chamfer.

**Proper Installation:** Use techniques and materials according to Borgert's specifications; keep the site clean and unclogged during installation.

**Surrounding Vegetation and Planting:** Ensure that the adjacent landscaping is strong, prevents erosion of soils onto the pavers, and does not contribute to clogging from falling leaves or fruits. Promptly remove grass clippings.

**Awareness:** Ensure anyone working near the site is aware of the system and does not place landscaping materials on the system or close enough to cause future runoff and no snow is piled throughout the winter. Do not allow sanding during the winter.

*Lack of maintenance will cause the system to clog, defeating the purpose of using permeable pavement.  
Clogging will also cause deterioration of the paver as it will sit in a constant state of saturation.*

## WINTER MAINTENANCE:

**Snow Removal:** Shovel or plow as immediately as possible following a snowfall. Do not pile on permeable surface.

**Salt/Deicing Chemicals:** Do not use sand. The best option is to use the joint material for grit.

**Salt:** When the system is clean and snow is removed promptly, far less salt/deicing chemicals should be used. Use proper judgement to gauge the amount of ice. There will most likely be little ice accumulation on the surface.

## EVIDENCE OF CLOGGING:

- Standing water during or directly following a minor storm event
- Visible debris in the joints
- Water running off or pooling in large areas
- Weed growth

## TOOLS:

### Preventative:

- Leaf blower
- Hard bristle broom

### Small Scale:

- Shop vacuum
- Small scale street vacuum

### Large Scale:

- Regenerative Air Vacuum: Will remove the top ½" of debris and joint material, new joint material must be swept back into the joints. This is a restorative technique that will return the system to near its initial infiltration capacity.
- Street Sweeper: Will remove loose debris on the pavers or on the top layer of the joints. This will not remove embedded debris and should be performed more frequently to avoid the need for more restorative tactics.

## MAINTENANCE PLAN:

- Inspect the area directly following a rain event to check for standing water (after a major event & at least 3 times a year)
- Use small-scale techniques to address small areas of clogging
- Maintain the correct level of joint material
- General preventative maintenance to reduce the need for major restorative techniques
- Regenerative Air Vacuum: when major clogging occurs. Recommended 1 - 2 times a year for commercial applications and once every 1-5 years for residential applications, vacuuming frequency depends on usage.



# SLABS

## BRÜKSTONE®

Slabs

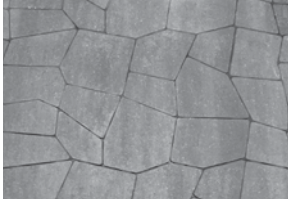
STYLE		CODE	DIMENSIONS	CUBES
<b>BrükStone®</b> <b>80mm Thickness</b>		<b>4BU</b>	14 Various Sizes - Returns of full cubes only - NOT SOLD BY THE BAND	76.08 SF 2690#

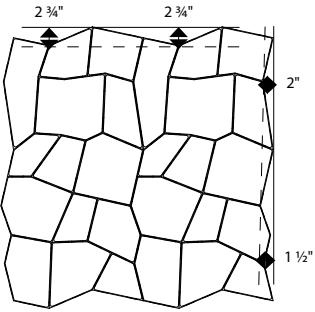

**Note:** There are 6 layers per cube at 12.68 SF per layer. Layer dimension is 44<sup>3</sup>/<sub>4</sub>" x 41<sup>3</sup>/<sub>4</sub>".  
- All borders that are cut in may require additional product.

Dimensions for straight edge points are indicated by - - - - -

**Note:** All spacer bars must line up with each other.  
Use a protective plate during compaction.

Suggested soldier course products Vavel II and Bavaria II.

### BrükStone® Stock Colors

STOCK COLORS	CODE	STOCK COLORS	CODE	STOCK COLORS	CODE
<b>Minnesota River</b>	<b>18</b>	<b>North Shore</b>	<b>40</b>	<b>Sterling Gray</b>	<b>05</b>

**For best blend results, always select from multiple cubes.**

## OLD MUNICH

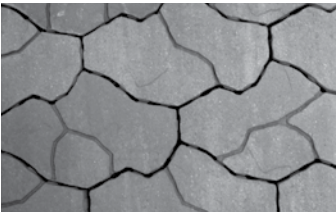
STYLE		CODE	DIMENSIONS	CUBES
<b>Old Munich</b> <b>70mm Thickness</b>		<b>40M</b>	355mm x 558mm x 70mm Approximate 13 <sup>7</sup> / <sub>8</sub> " x 21 <sup>7</sup> / <sub>8</sub> " x 2 <sup>3</sup> / <sub>4</sub> " - Returns of full cubes only - NOT SOLD BY THE BAND There are 7 layers per cube at 11.10 SF per layer. - Sizes are all the same, the dummy groove creates the look of various sizes.	77.7 SF 2525#

**Note:** Use protective plate during compaction.

### Old Munich Stock Colors



STOCK COLORS	CODE	STOCK COLORS	CODE	STOCK COLORS	CODE
<b>Boulder Blend</b>	<b>37</b>	<b>Iron Range</b>	<b>45</b>	<b>Minnesota River</b>	<b>18</b>
<b>Sterling Gray</b>	<b>05</b>				

**For best blend results, always select from multiple cubes.**

**Slabs are NOT unit pavers and precautions are necessary when installing these products.**

**Notes:** BrükStone® and Old Munich are minimal stock items. See slab installation guide on page 26.

# KASTLE FLATS RECTANGLE SLABS

STYLE		CODE	DIMENSIONS	BANDS	CUBES
<b>Kastle Flats Rectangle - Textured</b> <b>8" x 16"</b>		<b>4KA</b>	200mm x 400mm x 60mm Approximate 7 <sup>3</sup> / <sub>4</sub> " x 15 <sup>5</sup> / <sub>8</sub> " x 2 <sup>3</sup> / <sub>8</sub> " (PSF = 1.16 stones @ 28#)	N/A	92.94 SF 2602# (108 stones)
<b>Kastle Flats Rectangle - Smooth</b>		<b>4KAS</b>			
<b>Kastle Flats Square - Textured</b> <b>16" x 16"</b>		<b>4KB</b>	400mm x 400mm x 60mm Approximate 15 <sup>5</sup> / <sub>8</sub> " x 15 <sup>5</sup> / <sub>8</sub> " x 2 <sup>3</sup> / <sub>8</sub> " (PSF = .57 stones @ 28#)	N/A	81.84 SF 2292# (48 stones)
<b>Kastle Flats Square - Smooth</b>		<b>4KBS</b>			
<b>Kastle Flats Lg. Rec. - Textured</b> <b>16" x 24"</b>		<b>4KC</b>	400mm x 600mm x 60mm Approximate 15 <sup>5</sup> / <sub>8</sub> " x 23 <sup>1</sup> / <sub>2</sub> " x 2 <sup>3</sup> / <sub>8</sub> " (PSF = .39 stones @ 28#)	N/A	81.84 SF 2292# (32 stones)
<b>Kastle Flats Lg. Rec. - Smooth</b>		<b>4KCS</b>			

*Note: Use protective plate during compaction.*

## Kastle Flats Stock Colors

STOCK COLORS	CODE	STOCK COLORS	CODE
<b>Classic Bronze</b>	<b>47</b>	<b>Sterling Gray</b>	<b>05</b>

**NEW IN 2020**  
**KASTLE FLATS SMOOTH**

*For best blend results, always select from multiple cubes.*

## Kastle Flats Patterns

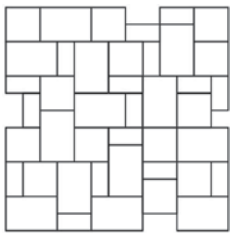

(A) 3 Piece Random  
8x16 - 16%  
16x16 - 34%  
16x24 - 50%  
Laying Ratio: 1:1:1

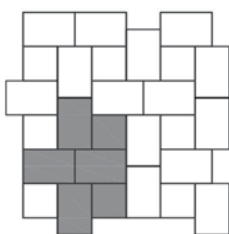

(B) 2 Piece  
16x16 - 30%  
16x24 - 70%  
Laying Ratio: 2:4

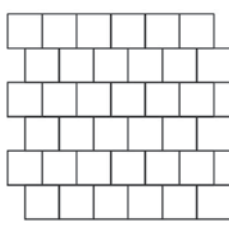

(C) 1 Piece  
16x16 - 100%

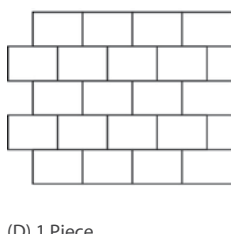

(D) 1 Piece  
16x24 - 100%

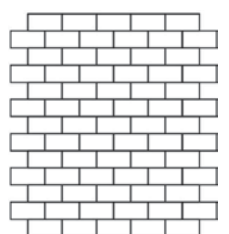

(E) 1 Piece  
8x16 - 100%

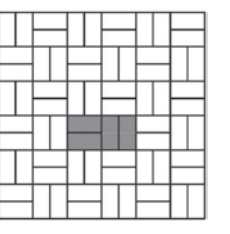

(F) 1 Piece  
8x16 - 100%

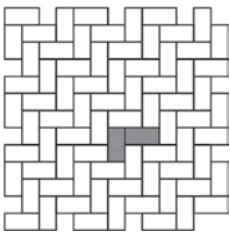

(G) 1 Piece  
8x16 - 100%

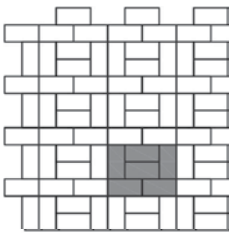

(H) 1 Piece  
8x16 - 100%

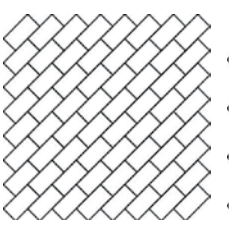

(I) 1 Piece  
8x16 - 100%

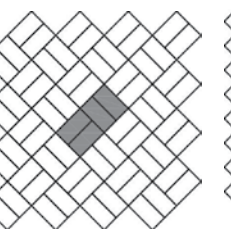

(J) 1 Piece  
8x16 - 100%

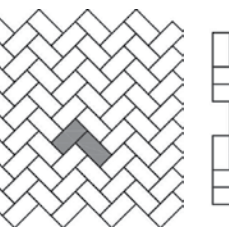

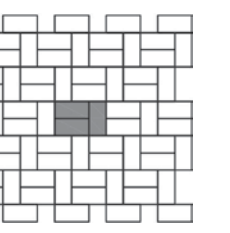

(K) 1 Piece  
8x16 - 100%



(L) 1 Piece  
8x16 - 100%

Need help figuring your project? Use our Stone Calculator online at [www.borgertproducts.com](http://www.borgertproducts.com).

# BULOVAR® LINEAR SLAB SERIES

STYLE		CODE	DIMENSIONS	CUBES
<b>Bulovar® 100mm Thickness</b>		<b>4BW</b>	75mm x 400mm x 100mm Approximate 27/8" x 15 <sup>3</sup> / <sub>4</sub> " x 4" (PSF = 3.1 stones @ 44#) <i>- NOT SOLD BY THE BAND</i>	67.7 SF 2975# (210 pcs)
<b>Bulovar® Max* 100mm Thickness</b>		<b>4BM</b>	150mm x 400mm x 100mm Approximate 67/8" x 15 <sup>3</sup> / <sub>4</sub> " x 4" (PSF = 1.55 stones @ 44#) <i>- NOT SOLD BY THE BAND</i>	62 SF 2728# (96 pcs)

*\*Bulovar® Max is suitable for light traffic such as driveways. Lay product perpendicular to the traffic flow.*

## Linear Slab Series Stock Colors

STOCK COLORS	CODE	STOCK COLORS	CODE	STOCK COLORS	CODE
<b>Adobe</b>	<b>87</b>	<b>Graphite</b>	<b>26</b>	<b>Pewter</b>	<b>20</b>
<b>Slate</b>	<b>32</b>				

*For best blend results, always select from multiple cubes.  
Available in custom colors. Inquire with your sales representative.*

**Slabs are NOT unit pavers and precautions are necessary when installing these products.**

*Note: See slab installation guide on page 26.*

## Installation Guide for Slabs: BrückStone®, Bulovar®, Kastle Flats, & Old Munich

**Slabs are NOT unit pavers and precautions are necessary when installing these products.**

**IMPORTANT:** Prior to screeding the bedding sand, the recommended base surface tolerance must not exceed ±¼ in. (±6 mm) over a 10 ft. (3 m) straight edge.

Keep heavy steer and forklift equipment off newly laid slabs that have not received initial compaction and joint sand.

**IMPORTANT NOTE:** Any Slab being brought to the laying face should be bridged with plywood to spread the loads applied from machine access.

Use a low-amplitude plate compactor with no more than 2,500 lbf (11 kN) at a frequency of 50 to 65 Hz with a **protective plate** to vibrate the slabs into the sand. Remove any cracked or damaged slabs and replace with new units. Sweep sand onto the surface and continue compacting and sanding until joints are full.

**ATTENTION: DUE TO THE SIZE OF THE SLAB, SOME BREAKAGE IS NORMAL.**

# WALLS

## STRASSEN® WALL

STYLE		CODE	DIMENSIONS	BANDS	CUBES
<b>Strassen® Wall Pallet "A"</b> 4"H x 12"L x 8"D		<b>8SW</b>	200mm x 300mm x 100mm Approximate 4" x 11¾" x 7⅞" To figure quantity: Sq.Ft. of wall ÷ .33 = number of units needed.	N/A	2825# (96 pcs)
<b>Strassen® Wall Pallet "B"*</b> 4"H x 8"L x 8"D		<b>8SWB</b>	100mm x 200mm x 200mm Approximate 4" x 7⅞" x 7⅞" To figure quantity: Sq.Ft. of wall ÷ .22 = number of units needed.	N/A	1650# (96 pcs)
<b>Strassen® Wall Pallet "C"*</b> 4"H x 4"L x 8"D		<b>8SWC</b>	100mm x 100mm x 200mm Approximate 4" x 4" x 7⅞" To figure quantity: Sq.Ft. of wall ÷ .11 = number of units needed.	N/A	1175# (144 pcs)
<b>Strassen® Wall Trapezoid</b> 4"H x 8"D		<b>8ST</b>	Wide end = 7.75" Narrow end = 5.5"	N/A	945# (63 pcs)
<b>Strassen® Wall Precast Cap</b> 2½"H x 30"L x 11"W		<b>5SPC</b>	<b>SEE ACCENTS PAGE 44</b>	N/A	1785# (21 pcs)
<b>Strassen® Precast Fire Kit Cap</b>		<b>5SPF</b>	<b>SEE ACCENTS PAGE 44</b> (4 units per trapezoid fire ring)	N/A	1280# (16 pcs)
<b>42" Diameter Precast Pub Table Top</b>		<b>5SPT</b>	<b>SPECIAL ORDER</b>	N/A	

\*Strassen Wall B & C are minimal stock items.

### Strassen® Wall Stock Colors

STOCK COLORS	CODE	STOCK COLORS	CODE	STOCK COLORS	CODE
<b>Boulder Blend</b>	<b>37</b>	<b>Charcoal</b> (Pallet A & trapezoid only)	<b>08</b>	<b>Iron Range</b>	<b>45</b>
<b>Minnesota River</b>	<b>18</b>	<b>North Shore</b>	<b>40</b>	<b>Sterling Gray</b>	<b>05</b>

For best blend results, always select from multiple cubes.

For Strassen Wall design details see page 29-31.

See page 44 for precast cap options.

Need help figuring your project? Use our Stone Calculator online at [www.borgertproducts.com](http://www.borgertproducts.com).

# STRASSEN® WALL II - NON-TUMBLED STOCK

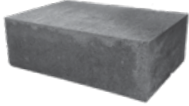
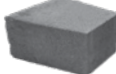
STYLE		CODE	DIMENSIONS	BANDS	CUBES
<b>Strassen® Wall II Pallet "A"</b> 4"H x 12"L x 8"D		<b>8USW</b>	200mm x 300mm x 100mm Approximate 4" x 11¾" x 7⅞" To figure quantity: Sq.Ft. of wall ÷ .33 = number of units needed.	N/A	2589# (88 pcs)
<b>Strassen® Wall II Trapezoid</b> 4"H x 8"D		<b>8UST</b>	Wide end = 7.75" Narrow end = 5.5"	N/A	945# (63 pcs)

## Strassen® Wall II Stock Colors

STOCK COLORS	CODE	STOCK COLORS	CODE	STOCK COLORS	CODE
<b>Charcoal</b>	<b>08</b>	<b>Minnesota River</b>	<b>18</b>	<b>Sterling Gray</b>	<b>05</b>

*For best blend results, always select from multiple cubes.*

**See page 44 for precast cap options.**

**Not available in Colorado.**

Need help figuring your project? Use our Stone Calculator online at [www.borgertproducts.com](http://www.borgertproducts.com).



# Wall Details - Strassen® Wall & Strassen® Wall II

## NUMBER OF STRASSEN WALL NEEDED – USING 8" SIDE

WALL HEIGHT	NO. OF COURSES	WALL LENGTH MEASURED IN FEET					
		5 ft.	10 ft.	20 ft.	30 ft.	40 ft.	50 ft.
4 in.	1	7.5 pcs.	15 pcs.	30 pcs.	45 pcs.	60 pcs.	75 pcs.
8 in.	2	15 pcs.	30 pcs.	60 pcs.	90 pcs.	120 pcs.	150 pcs.
12 in.	3	22.5 pcs.	45 pcs.	90 pcs.	135 pcs.	180 pcs.	225 pcs.
16 in.	4	30 pcs.	60 pcs.	120 pcs.	180 pcs.	240 pcs.	300 pcs.

See Borgert Stone Calculator for figuring larger walls at [www.borgertproducts.com](http://www.borgertproducts.com)

Maximum wall height not to exceed 16".

## NUMBER OF STRASSEN WALL NEEDED – USING 12" SIDE

WALL HEIGHT	NO. OF COURSES	WALL LENGTH MEASURED IN FEET					
		5 ft.	10 ft.	20 ft.	30 ft.	40 ft.	50 ft.
4 in.	1	5 pcs.	10 pcs.	20 pcs.	30 pcs.	40 pcs.	50 pcs.
8 in.	2	10 pcs.	20 pcs.	40 pcs.	60 pcs.	80 pcs.	100 pcs.
12 in.	3	15 pcs.	30 pcs.	60 pcs.	90 pcs.	120 pcs.	150 pcs.
16 in.	4	20 pcs.	40 pcs.	80 pcs.	120 pcs.	160 pcs.	200 pcs.

## Trapezoid Details - Strassen® Wall, Strassen® & Strassen® Wall II

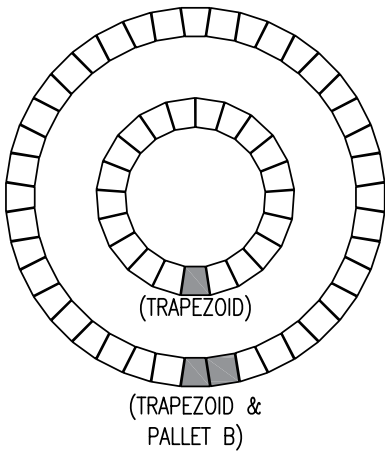

(TRAPEZOID) 1 piece  
Strassen Trapezoid Units – 21  
Radius: inside 1'-7" / outside 2'-3"  
Diameter: inside 3'-2" / outside 4'-6"

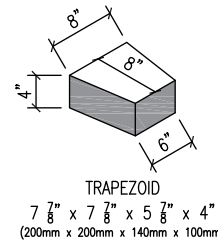

(TRAPEZOID & PALLET A) 2 piece  
Strassen Trapezoid Units – 20  
Strassen Wall Units – 20  
Radius: inside 4'-8" / outside 5'-4"  
Diameter: inside 9'-4" / outside 10'-8"  
Laying Ratio: 1:1

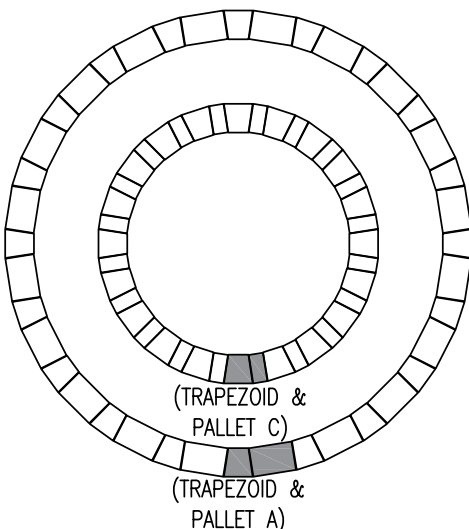
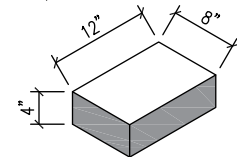

(TRAPEZOID & PALLET B) 2 piece  
Strassen Trapezoid Units – 20  
Strassen Wall Units – 20  
Radius: inside 3'-8" / outside 4'-4"  
Diameter: inside 7'-4" / outside 8'-8"  
Laying Ratio: 1:1

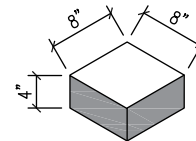

(TRAPEZOID & PALLET C) 2 piece  
Strassen Trapezoid Units – 20  
Strassen Wall Units – 20  
Radius: inside 2'-6 1/2" / outside 3'-2 1/2"  
Diameter: inside 5'-1" / outside 6'-5"  
Laying Ratio: 1:1

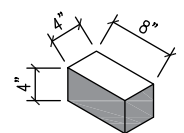

# 8KFR - Fire Ring - Strassen® Wall Trapezoid Fire Kit (No Cut)

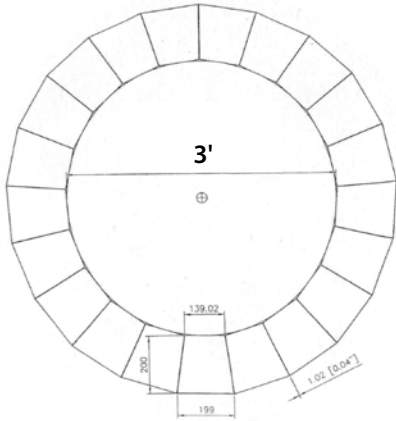

\*Outside dimension is 4'4"

## PACKING LIST

- (63) Strassen Wall Trapezoid Units (21 units per layer)
- (1) 3' x 12" high Metal Ring
- (3) 10 oz. Tubes SRW Adhesive 945#

Trapezoid Colors: Boulder Blend, Charcoal, Iron Range, MN River, North Shore, & Sterling Gray.  
Trapezoid II - Non-tumbled Colors: Charcoal, MN River & Sterling Gray.

Strassen Precast Fire Kit Cap Colors: Charcoal, Limestone & Brown  
(Sold separately) - 4 needed per fire ring.

### Optional & Sold Separately

- Strassen® Wall Fire Pit Cap (4 needed per ring)

## IMPORTANT NOTE ON FIRE RING CAPS:

There are no warranties, expressed or implied, on this product. When burning in the fire ring, leave a gap between the burning wood and the fire ring cap to allow heat to escape the fire. Failure to have an air buffer between the fire pit caps and the burning wood can result in heat stress cracks in the fire ring caps. Fire rings are for burning wood only. Burning other material may increase the fire temperature resulting in a higher risk for heat cracking.

# 8KFS - Square Fire Pit Ring - Strassen® Wall Fire Kit (No Cut) - 35½" x 35½" x 12"

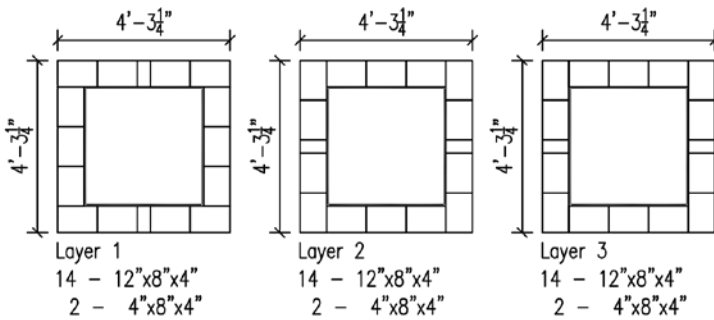

**Note: Please allow 5 days notice on kits.  
No returns on unused kit items.**

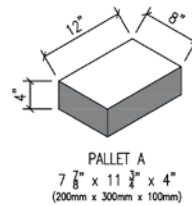

PALLET A  
7 7/8" x 11 3/4" x 4"  
(200mm x 300mm x 100mm)

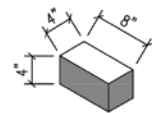

PALLET C  
7 7/8" x 4" x 4"  
(200mm x 100mm x 100mm)

## PACKING LIST

- (42) Pallet A
- (6) Pallet C
- (3) 10.5 oz. Tubes SRW Adhesive
- (1) Steel Square
- 1285#

Wall Colors: Boulder Blend, Iron Range, MN River, North Shore, & Sterling Gray.

## Strassen® Wall Patterns

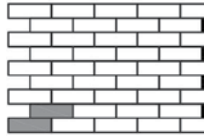

Pallet "A"  
4"H x 12"L x 8"D - 100%

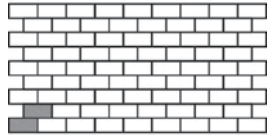

Pallet "B"  
4"H x 8"L x 8"D - 100%

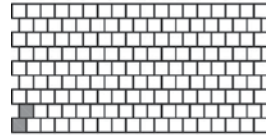

Pallet "C"  
4"H x 4"L x 8"D  
- 100%

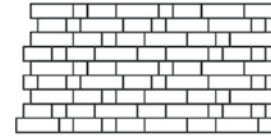

Random  
Pallet "A,B & C"  
4"H x 12"L x 8"D - 50%  
4"H x 8"L x 8"D - 33%  
4"H x 4"L x 8"D - 17%  
Laying Ratio: 1:1:1

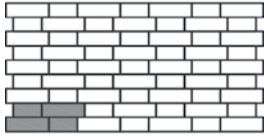

Pallet "A & B"  
4"H x 12"L x 8"D - 60%  
Pallet "B"  
4"H x 8"L x 8"D - 40%  
Laying Ratio: 1:1

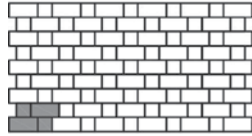

Pallet "B & C"  
4"H x 8"L x 8"D - 67%  
Pallet "C"  
4"H x 4"L x 8"D - 33%  
Laying Ratio: 1:1

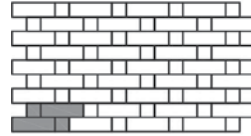

Pallet "A & C"  
4"H x 12"L x 8"D - 75%  
Pallet "C"  
4"H x 4"L x 8"D - 25%  
Laying Ratio: 1:1

**Note: For pattern purposes only, height is not implied.**

## Strassen® Column Details

APPROXIMATE COLUMN HEIGHT	NUMBER OF COLUMNS (20" x 20")				
	1	2	3	4	5
2 courses 8 in.	8	16	24	32	40
3 courses 12 in.	12	24	36	48	60
4 courses 16 in.	16	32	48	64	80
5 courses 20 in.	20	40	60	80	100
6 courses 24 in.	24	48	72	96	120
7 courses 28 in.	28	56	84	112	140
8 courses 32 in.	32	64	96	128	160

Adhesive is used to secure corners and top row units.

A 12" solid wall, random pattern = 24 square foot face per cube  
An 8" deep wall, running bond = 32 square foot face per cube

### Column Details:

Dimension of column = 20" x 20"

Strassen Wall units per foot = 12

Strassen Wall for Caps = 6 units (24" x 24").



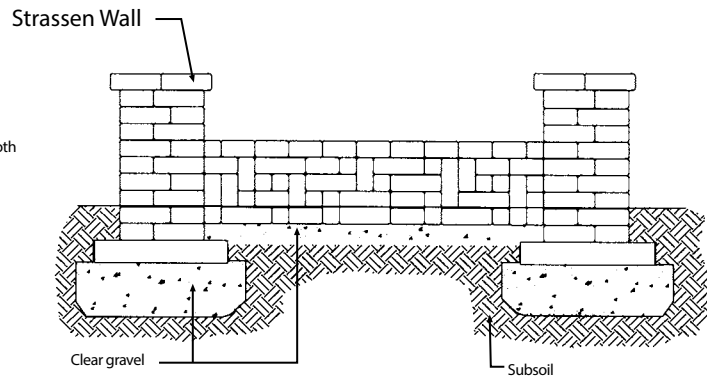
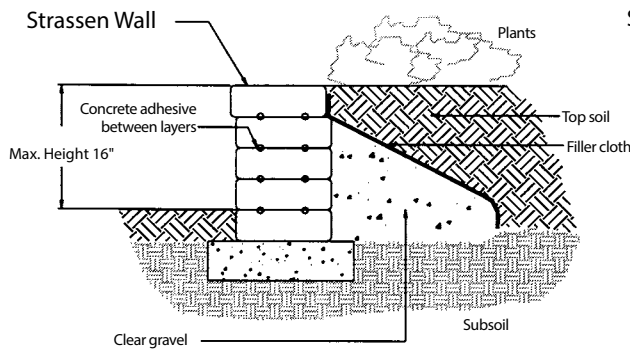

**Maximum column height not to exceed 32".**

## Strassen® Wall Cross Sections



Need help figuring your project? Use our Stone Calculator online at [www.borgertproducts.com](http://www.borgertproducts.com).

# MADERA WALL (AGED)

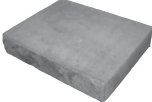
ITEM		CODE	DIMENSIONS	WEIGHT PER UNIT	UNITS PER PALLET	PER PALLET	PIECES PER LAYER
<b>Pallet "A"</b>		<b>8MWA</b>	Piece #1 - 6"H x 8"W x 12"D Piece #2 - 6"H x 12"W x 12"D Piece #3 - 6"H x 16"W x 12"D	32# 55# 78#	12 12 12	15 SF (30 LinFt) 2100#	3 Layers (12 pcs)
<b>Pallet "B"</b>		<b>8MWB</b>	Piece #5 - 6"H x 24"W x 12"D Piece #6 - 6"H x 28"W x 12"D	124# 147#	9 9	18 SF (36 LinFt) 2520#	3 Layers (6 pcs)
<b>Pallet "D" - 3" High</b>		<b>8MWD</b>	Piece #1 - 3"H x 8"W x 12"D Piece #2 - 3"H x 12"W x 12"D Piece #3 - 3"H x 16"W x 12"D	16# 27.5# 39#	24 24 24	15 SF (60 LinFt) 2160#	6 Layers (12 pcs)
<b>Madera Column Unit</b>		<b>8MC</b>	6"H x 8"W x 12"D	47#	54	2538#	
<b>Madera Split Cap</b>		<b>8CMC</b>	3"H x 14"W x 15"D	50#	36	1800#	

**NOTE:** See pages 37, 40 & 41 for more retaining wall information and basic grid charts.  
Engineering form available on pages 38-39.

## Madera Wall & Split Cap Stock Colors

STOCK COLORS	CODE	STOCK COLORS	CODE	STOCK COLORS	CODE
<b>Charcoal</b> <i>(Cap only)</i>	<b>08</b>	<b>Iron Range</b>	<b>45</b>	<b>Minnesota River</b>	<b>18</b>
<b>North Shore</b>	<b>40</b>	<b>Sterling Gray</b>	<b>05</b>		

**For best blend results, always select from multiple cubes.**

**NOTE:** Madera is for freestanding and/or gravity walls.

# Madera & Morteza Wall Patterns

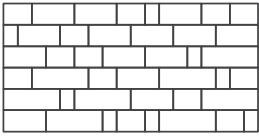

(A)  
Pallet "A"  
Piece #1 - 6"H x 8"L x 12"D  
Piece #2 - 6"H x 12"L x 12"D  
Piece #3 - 6"H x 16"L x 12"D  
Laying Ratio: 1:1:1

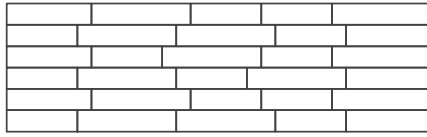

(B)  
Pallet "B"  
Piece #5 - 6"H x 24"L x 12"D  
Piece #6 - 6"H x 28"L x 12"D  
Laying Ratio: 1:1

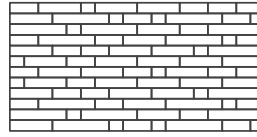

(D)  
Pallet "D"  
Piece #1 - 3"H x 8"L x 12"D  
Piece #2 - 3"H x 12"L x 12"D  
Piece #3 - 3"H x 16"L x 12"D  
Laying Ratio: 1:1:1

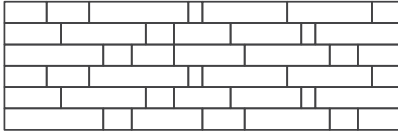

(F)  
Pallet "A & B"  
Piece #1 - 6"H x 8"L x 12"D  
Piece #2 - 6"H x 12"L x 12"D  
Piece #3 - 6"H x 16"L x 12"D  
Piece #5 - 6"H x 24"L x 12"D  
Piece #6 - 6"H x 28"L x 12"D  
Laying Ratio: 1:1:1:1:1

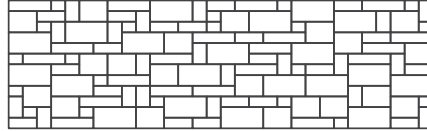

(I)  
Pallet "A & D"  
Piece #1 - 6"H x 8"L x 12"D  
Piece #2 - 6"H x 12"L x 12"D  
Piece #3 - 6"H x 16"L x 12"D  
Piece #1 - 3"H x 8"L x 12"D  
Piece #2 - 3"H x 12"L x 12"D  
Piece #3 - 3"H x 16"L x 12"D  
Laying Ratio: 1:1:1:1:1:1

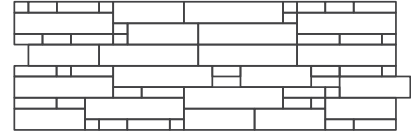

(J)  
Pallet "B & D"  
Piece #1 - 3"H x 8"L x 12"D  
Piece #2 - 3"H x 12"L x 12"D  
Piece #3 - 3"H x 16"L x 12"D  
Piece #5 - 6"H x 24"L x 12"D  
Piece #6 - 6"H x 28"L x 12"D  
Laying Ratio: 1:1:1:1:1

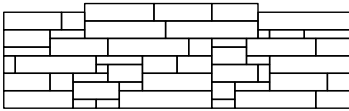





(L)  
Pallet "A,B,C & D"  
Piece #1 - 6"H x 8"L x 12"D  
Piece #2 - 6"H x 12"L x 12"D  
Piece #3 - 6"H x 16"L x 12"D  
Piece #4 - 6"H x 20"L x 12"D  
Piece #5 - 6"H x 24"L x 12"D  
Piece #6 - 6"H x 28"L x 12"D  
Piece #7 - 6"H x 32"L x 12"D  
Piece #1 - 3"H x 8"L x 12"D  
Piece #2 - 3"H x 12"L x 12"D  
Piece #3 - 3"H x 16"L x 12"D  
Laying Ratio: 1:1:1:1:1:1:1:1:1

Need help figuring your project? Use our Stone Calculator online at [www.borgertproducts.com](http://www.borgertproducts.com).

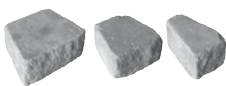

## MORTEZA WALL UNITS (NON-AGED)

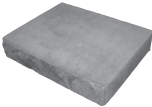
ITEM		CODE	DIMENSIONS	WEIGHT PER UNIT	UNITS PER PALLET	PER PALLET	PIECES PER LAYER
<b>Pallet "A"</b>		<b>8UMWA</b>	Piece #1 - 6"H x 8"W x 12"D Piece #2 - 6"H x 12"W x 12"D Piece #3 - 6"H x 16"W x 12"D	32# 55# 78#	12 12 12	15 SF (30 LinFt) 2100#	3 Layers (12 pcs)
<b>Pallet "B"</b>		<b>8UMWB</b>	Piece #5 - 6"H x 24"W x 12"D Piece #6 - 6"H x 28"W x 12"D	124# 147#	9 9	18 SF (36 LinFt) 2520#	3 Layers (6 pcs)
<b>Pallet "D" - 3" High</b>		<b>8UMWD</b>	Piece #1 - 3"H x 8"W x 12"D Piece #2 - 3"H x 12"W x 12"D Piece #3 - 3"H x 16"W x 12"D	16# 27.5# 39#	24 24 24	15 SF (60 LinFt) 2160#	6 Layers (12 pcs)
<b>Morteza Column Unit</b>		<b>8UMC</b>	6"H x 8"W x 12"D	47#	54	2538#	
<b>Morteza Split Cap</b>		<b>8UCMC</b>	3"H x 14"W x 15"D	50#	36	1800#	

**NOTE:** See pages 37, 40 & 41 for more retaining wall information and basic grid charts.  
Engineering form available on pages 38-39.

### Morteza Wall & Split Cap Stock Colors

STOCK COLORS	CODE	STOCK COLORS	CODE	STOCK COLORS	CODE
<b>Charcoal</b> <i>(Cap only)</i>	<b>08</b>	<b>Iron Range</b>	<b>45</b>	<b>Minnesota River</b>	<b>18</b>
<b>North Shore</b>	<b>40</b>	<b>Sterling Gray</b>	<b>05</b>		

**For best blend results, always select from multiple cubes.**

**NOTE:** Morteza is for freestanding and/or gravity walls.

Need help figuring your project? Use our Stone Calculator online at [www.borgertproducts.com](http://www.borgertproducts.com).

# Madera & Morteza Wall Units Circles

## Radius with Pallet "A" Pieces

Inner diameter = 4'  
Outer diameter = 6'

- Pc 1: 6 pcs
- Pc 2: 6 pcs
- Pc 3: 6 pcs

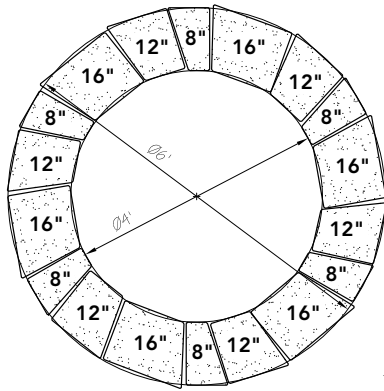

Inner diameter = 2'  
Outer diameter = 4'

- Pc 1: 19 pcs

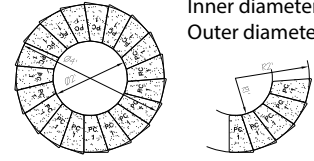

Inner diameter = 3'6"  
Outer diameter = 5'6"

- Pc 1: 10 pcs
- Pc 2: 10 pcs

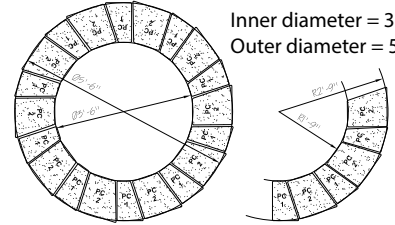

Inner diameter = 4'  
Outer diameter = 6'

- Pc 2: 18 pcs

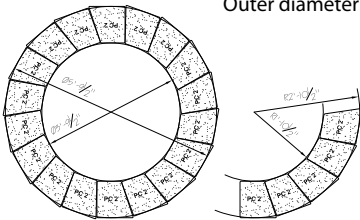

Inner diameter = 5'  
Outer diameter = 7'

- Pc 2: 9 pcs
- Pc 3: 9 pcs

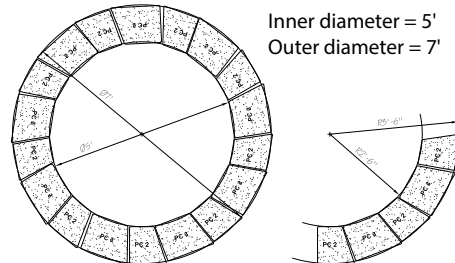

Inner diameter = 5'8"  
Outer diameter = 7'10"

- Pc 3: 18 pcs

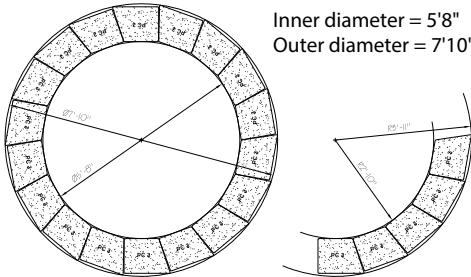

Inside radius = 4'3"  
Outside radius = 5'3"

- Pc 3
- Pc 4

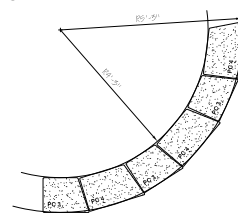

Inside radius = 4'3"  
Outside radius = 5'3"

- Pc 4

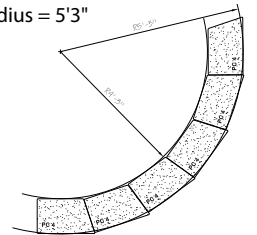

Inside radius = 4'9.5"  
Outside radius = 5'9.5"

- Pc 4
- Pc 5

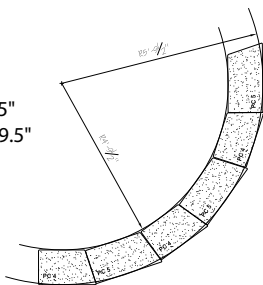

Inside radius = 5'10"  
Outside radius = 6'10"

- Pc 5
- Pc 6

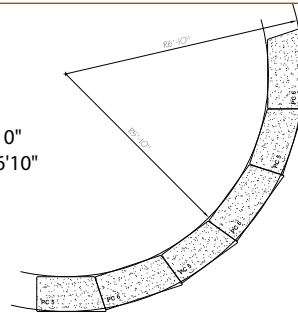

Inside radius = 5'4"  
Outside radius = 6'4"

- Pc 5

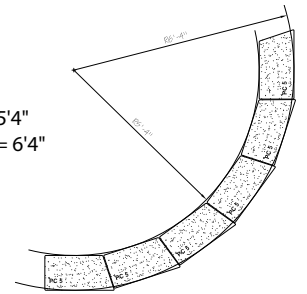

Inside radius = 6'4"  
Outside radius = 7'4"

- Pc 6

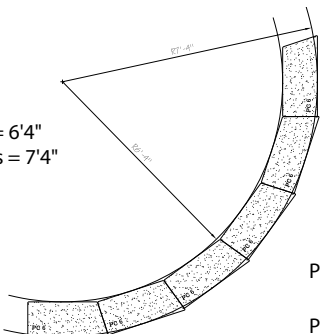

Inside radius = 6'11"  
Outside radius = 7'11"

- Pc 6
- Pc 7

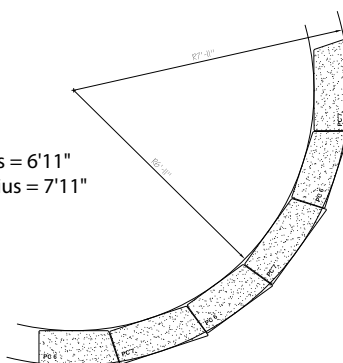

Inside radius = 7'5"  
Outside radius = 8'5"

- Pc 7

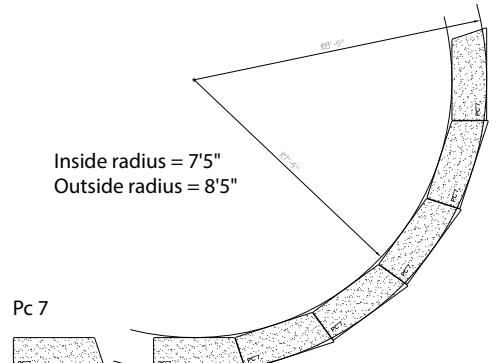

**NOTE: For the radii using only one size, not all pieces in the pallet will be used. Extra pieces cannot be returned for credit.**

# PANOMUR® WALL

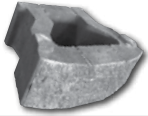
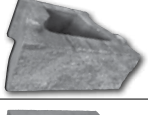
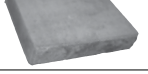
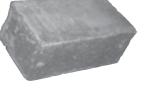
ITEM		CODE	DIMENSIONS	WEIGHT PER UNIT	UNITS PER PALLET	WEIGHT PER PALLET
<b>PanoMur Wall 6" Curved Split Face</b>		<b>8PW</b>	6"H x 16"W x 12"D	49#	45	2205#
<b>PanoMur Wall 6" Straight Split Face</b>		<b>8PWS</b>	6"H x 16"W x 12"D	49#	45	2205#
<b>PanoMur Caps - Split</b>		<b>8PC</b>	3"H x 16"W x 12"D	47#	60	2850#
<b>PanoMur Corner Units</b>		<b>8PQ</b>	6"H x 16"W x 8"D	60#	36	2160#

**NOTE: See pages 37, 40 & 41 for more retaining wall information and basic grid charts. Engineering form available on pages 38-39.**

Core fill with crushed aggregate. To figure quantity: Sq.Ft. of wall ÷ .67 = number of units needed.

## PanoMur® Wall & Split Cap Stock Colors

STOCK COLORS	CODE	STOCK COLORS	CODE	STOCK COLORS	CODE
<b>Buff</b>	<b>33</b>	<b>Minnesota River</b>	<b>18</b>	<b>Sterling Gray</b>	<b>05</b>

*For best blend results, always select from multiple cubes.*

## PanoMur® Wall Smallest Circle Dimensions



### Standard PanoMur® Full Unit Circle

15 Units Total  
**Diameter**  
 6½ ft outside diameter  
 4½ ft inside diameter  
**Radius**  
 3¼ ft outside radius  
 2¼ ft inside radius  
*These measurements are nominal*



### PanoMur® Unit Circle with Handhelds Removed

12 Units Total  
**Diameter**  
 5½ ft outside diameter  
 3½ ft inside diameter  
**Radius**  
 2¾ ft outside radius  
 1¾ ft inside radius  
*These measurements are nominal*

## PanoMur® Inside & Outside Corner Details

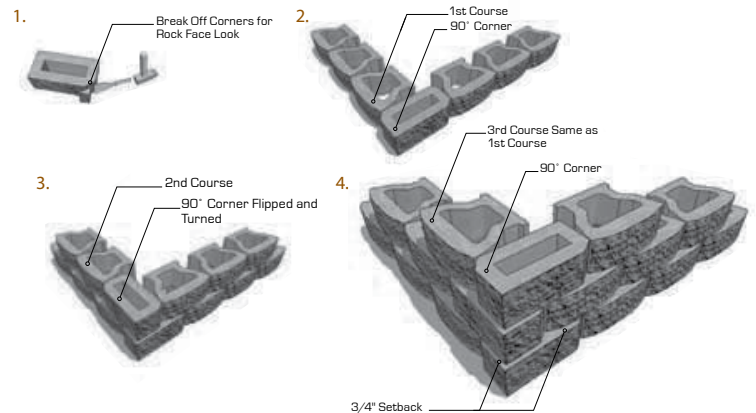
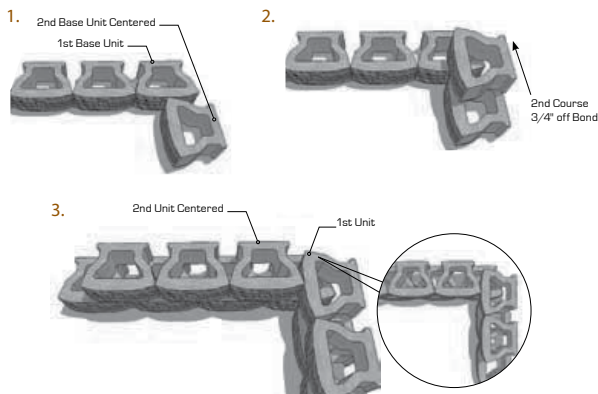

**Note: PanoMur® has a 6° batter**

# RETAINING WALL INSTALLATION GUIDE

## INSTALLATION GUIDE FOR PANOMUR RETAINING WALLS

See SRW's "Standard Engineering and How-To-Guide" for more information.

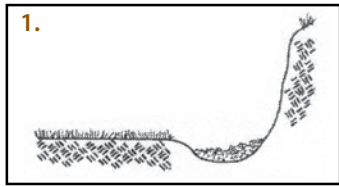

**1. Excavate**  
Dig a base trench 24" inches to 36" inches wide and a minimum of 12" inches deep. Remove all vegetation and unsuitable organic soils (Do not use these for structural backfill). Compact soil base properly.

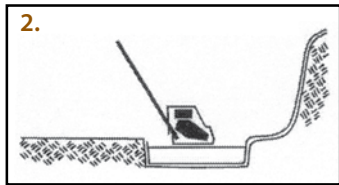

**2. Prepare Leveling Pad**  
Fill trench with 6" inches of well graded gravel and compact firmly with vibrating compaction equipment.

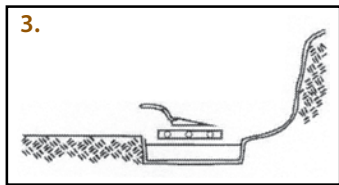

**3. Level the Base**  
Level the gravel base from front to back and side to side. This procedure will ensure a straight and stable wall.

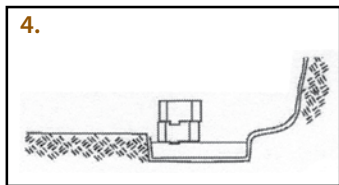

**4. Lay your First Course**  
Use a string line to align your first row of units. For smooth curves, use a flexpipe as your guide. Place each unit edge to edge, lining up the back of the units.

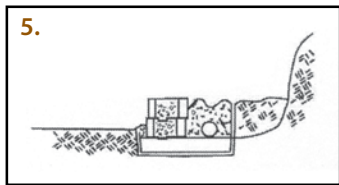

**5. Build your Wall**  
Sweep the top of each course of units to clear debris. Half-stagger the next course so each unit is centered on two units below. Pull each unit forward to lock connecting lugs in place.

**6. Install Backfill**  
Place perforated drainage pipe behind the base of your wall. Add 12" inches of free-draining

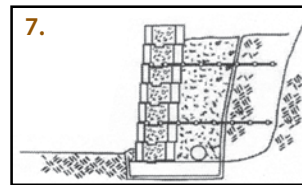
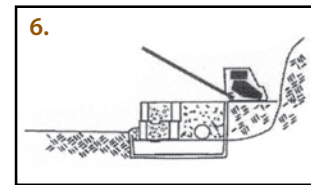

**7. Reinforce Wall**  
Place the geosynthetics on top and as close to the front of the units as possible. Lock the next course of units into place. Gently tension the geosynthetics toward the back of the compacted backfill. Repeat the backfilling steps. Always work from the back of the wall toward the end of the reinforced zone.

**8. Cap your Wall**  
Sweep off the top course of units. Secure caps to the top of the wall using an approved concrete adhesive. Use a level piece of string to properly align the capping. Place filter soil separation fabric on top of the backfill and drainage materials as well as the back side of the wall. Cover with top soil.

**Please note:**  
A qualified engineer should be consulted on PanoMur walls exceeding 3' feet (or 6 courses) in height.

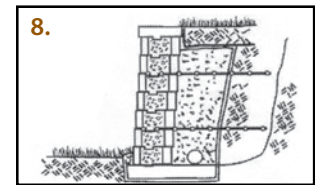

## RETAINING WALL CROSS SECTIONS

Typical Gravity Cross Section

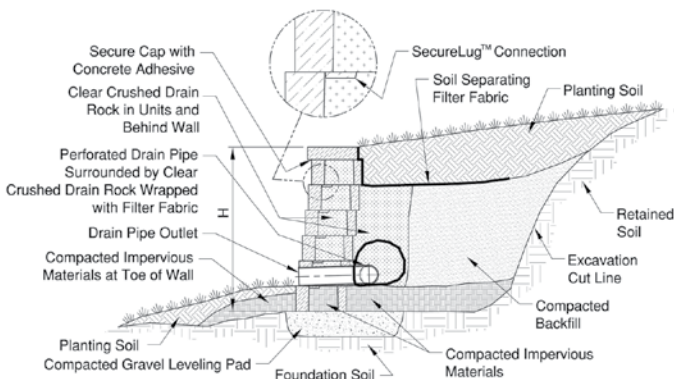

Typical Geo-Reinforced Cross Section

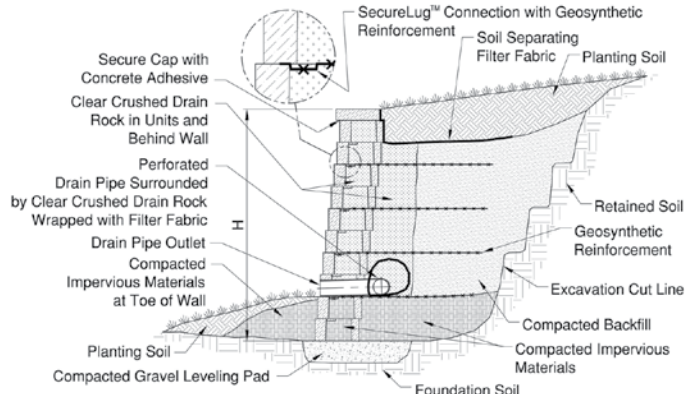

Need help figuring your project? Use our Stone Calculator online at [www.borgertproducts.com](http://www.borgertproducts.com).



# ENGINEERING REQUEST FORM

## For Retaining Walls Up To 8' Exposed Height



Property Owner: \_\_\_\_\_

Property Address: \_\_\_\_\_

City: \_\_\_\_\_ State: \_\_\_\_\_ Zip: \_\_\_\_\_

Phone: \_\_\_\_\_ Fax: \_\_\_\_\_

Email: \_\_\_\_\_

**PROJECT NAME:** \_\_\_\_\_

### WALL INFORMATION

Block Being Used: \_\_\_\_\_

Maximum exposed wall height (ft): \_\_\_\_\_

Is your retaining wall project multi-tiered or terraced (Multi-tiered walls are not presently included in this standard engineering program)?  Yes  No

Are grading plans available that show wall placement, elevations, lineal footage with grade lines and/or wall face profiles?  Yes  No

- If YES, include the plans with this request form.
- If NO, sketches of a plan view and/or the wall face profile(s) must be provided with this engineering request (See graph sheets and instructions provided for sketching of retaining walls)

Photos of the proposed retaining wall site must be provided with this engineering request. (See "Photograph Instructions")

### SLOPE INFORMATION

(See "Slope Angle Determination Instructions")

#### Top of wall

Is there a slope at the top of the wall (see diagram)?

Yes  No

- If YES, indicate the angle of slope (example, 2 horizontal to 1 vertical)  
Horizontal \_\_\_\_\_ to Vertical \_\_\_\_\_
- Is the slope rise (elevation change from top of wall to top of slope) the same as or greater than 2 times the height of the wall (see diagram)?  Yes  No

#### Bottom of wall

Is there a slope at the bottom/front of the wall (see diagram)?

Yes  No

- If YES, indicate the angle of slope (example, 2 horizontal to 1 vertical)  
Horizontal \_\_\_\_\_ to Vertical \_\_\_\_\_

Contractor/Installer: \_\_\_\_\_

Property Address: \_\_\_\_\_

City: \_\_\_\_\_ State: \_\_\_\_\_ Zip: \_\_\_\_\_

Phone: \_\_\_\_\_ Fax: \_\_\_\_\_

Email: \_\_\_\_\_

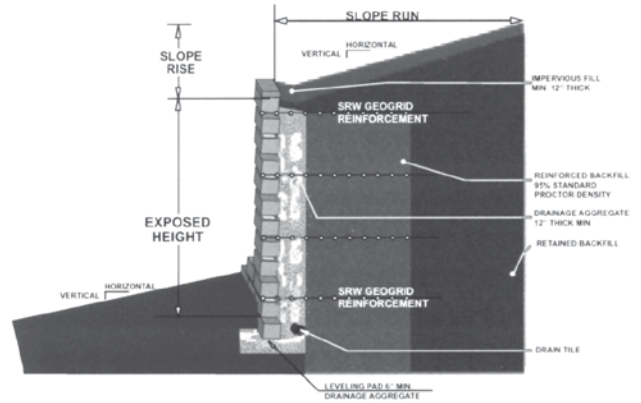

### SURCHARGE LOAD INFORMATION

Indicate type of load at the top of the wall.

- Lawn or grassy  Light auto parking/Drive  
 Heavy truck parking/Highway

Is there any other loading within 2 times the height of the retaining wall?  Yes  No

- Indicate what type of loading it is \_\_\_\_\_
- Indicate load distance from top of wall \_\_\_\_\_ (measured in feet from the face of the retaining wall)

### SOILS INFORMATION

Is there a soils report available?  Yes  No

- If yes, include soils report with this request form.
- If no, include soil sample as outlined in soil sampling instructions.

Leveling pad shall consist of well graded sand & gravel, gravel, or drainage aggregate.

### WATER INFORMATION

Is internal or external water involved? (External water would include run-off at the top of wall and/or a pond, lake or stream at the bottom of wall. Internal water could be seepage out of the retained soil.)  Yes  No

- If yes, indicate how water is involved.

\_\_\_\_\_

\_\_\_\_\_

\_\_\_\_\_

OTHER

Is there a steel, wood, or PVC fence at top of wall?

Yes No

Are there utilities etc. needing to go through the facing or reinforced soil? Yes No

RETURN STAMPED ENGINEERING

To: \_\_\_\_\_

Property Address: \_\_\_\_\_

City: \_\_\_\_\_ State: \_\_\_\_\_ Zip: \_\_\_\_\_

Phone: \_\_\_\_\_ Fax: \_\_\_\_\_

Email: \_\_\_\_\_

ADDITIONAL INFORMATION

Please write below anything additional that you feel the engineer needs to know about the retaining wall.

\_\_\_\_\_  
\_\_\_\_\_  
\_\_\_\_\_  
\_\_\_\_\_  
\_\_\_\_\_  
\_\_\_\_\_  
\_\_\_\_\_  
\_\_\_\_\_

PRODUCT INFORMATION

What retailer did you (or plan to) purchase the supplies for this project? \_\_\_\_\_

What company manufactured the block unit you are using for this project? \_\_\_\_\_

PAYMENT INFORMATION

Account Number: \_\_\_\_\_ - \_\_\_\_\_ - \_\_\_\_\_ Exp. Date: \_\_\_\_\_ / \_\_\_\_\_ Business Personal

3-digit Number (on back of card) \_\_\_\_\_ VISA MASTERCARD OTHER \_\_\_\_\_

Name On Card: \_\_\_\_\_

Complete Billing Address: \_\_\_\_\_

City: \_\_\_\_\_ State: \_\_\_\_\_ Zip: \_\_\_\_\_

**PLEASE FILL OUT ALL ITEMS ON THIS FORM.**

By submitting and signing this form I certify that the information provided herein is accurate and correct. HTS will forward all required information to a licensed and registered engineer in the state of the project. If any site conditions change (e.g. water seepage, soil changes, surcharge changes, or height changes etc.), are encountered, construction of retaining wall must be stopped and Hardscape Technical Services informed of the new conditions before placing ANY retaining wall units. It can then be determined if the stamped designs are appropriate or if changes are required. If faxed or emailed documentation is acceptable for your local building authorities, the turnaround time is estimated to be no longer than five working days from the day that Hardscape Technical Services receives all the required information, including payment. **HOWEVER**, if raised embossed stamping is required by your local building authorities, add the necessary time to return the stamped engineering by means other than electronic.

Information Supplied by (please print): \_\_\_\_\_

Signature (required): \_\_\_\_\_ Date (required): \_\_\_\_\_

Hardscape Technical Services (HTS), PO Box 369, Princeton, MN 55371, 866-582-0894, hts@hardscapetech.com

Need help figuring your project? Use our Stone Calculator online at [www.borgertproducts.com](http://www.borgertproducts.com).



# GEOGRID PLACEMENT TABLES

For walls up to 8' using PanoMur Block & SRW 3 Series Geogrid

If used without the stamped engineering, the final determination of the suitability of the contemplated use, and its manner of use, are the sole responsibility of the user, and the user expressly releases all parties of any and all liability that might arise as a result. These designs have been performed with National Concrete Masonry Association (NCMA) software and have been analyzed for the appropriate factors of safety. © 2009 Hardscape Technical Services • Visit [www.hardscapetech.com](http://www.hardscapetech.com) for stamped engineering services and additional design charts.

Grid Specification: SRW 3 Series - 1041 L TDS • Block Dimensions: 6"(H) x 16"(W) x 12"(D) • Covers: 2/3 Sq.Ft.

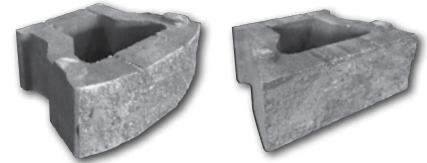

## 26 DEGREE SOIL

- Flat at Top and Bottom of Wall
- No Surcharge

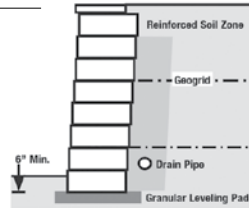

## GEOGRID PLACEMENT

- Grid is measured from the face of the wall.

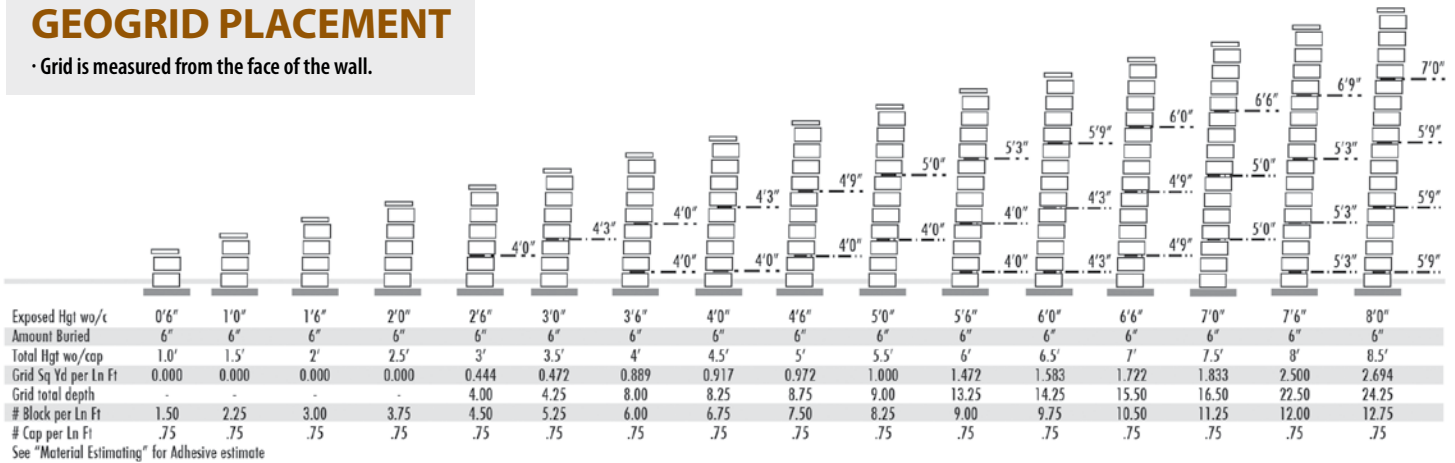

## 30 DEGREE SOIL

- Flat at Top and Bottom of Wall
- No Surcharge

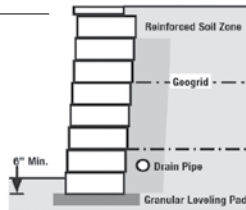

## GEOGRID PLACEMENT

- Grid is measured from the face of the wall.

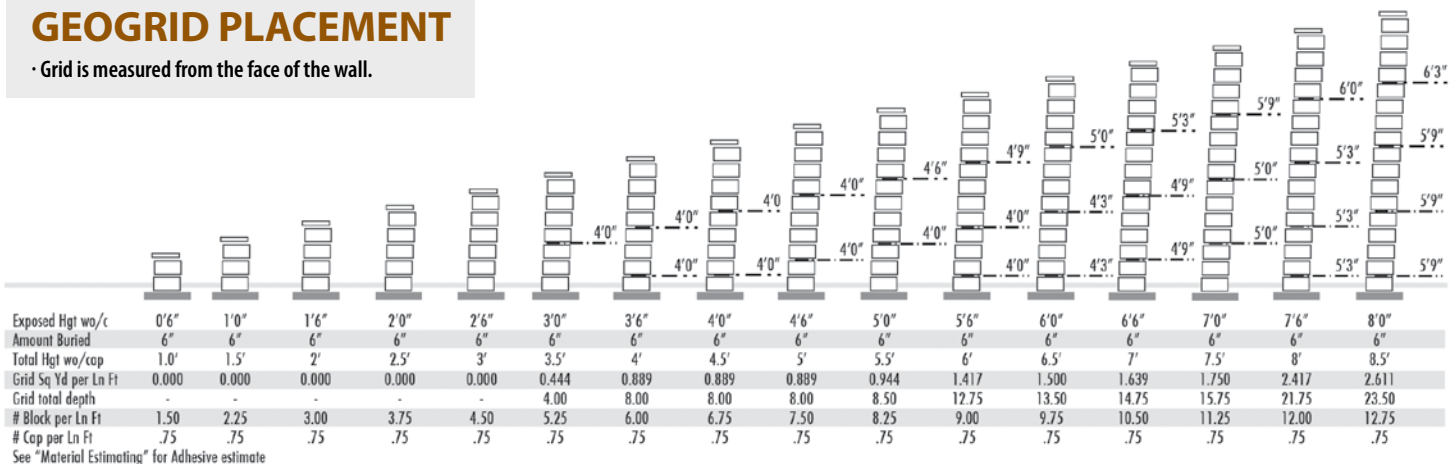

# Madera Wall & Morteza Wall

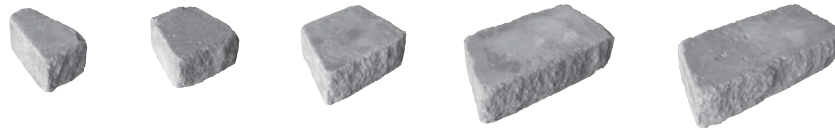

## 26 DEGREE SOIL

- Flat at Top and Bottom of Wall
- No Surcharge

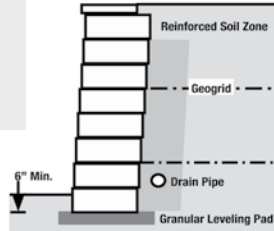

## GEOGRID PLACEMENT

- Grid is measured from the face of the wall.

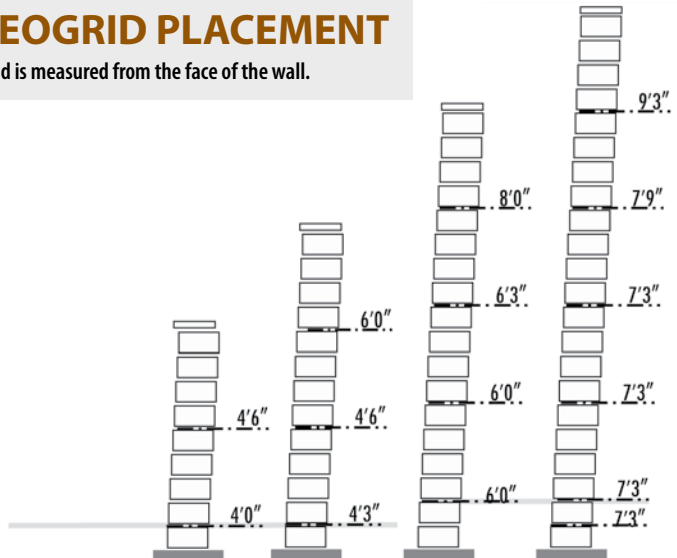

Exposed Hgt w/ cap	4'0"	6'0"	8'0"	10'0"
Amount Buried	6"	6"	1'0"	1'0"
Total Hgt w/ cap	4.5'	6.5'	9.0'	11.0'
Grid Sq Yd per Ln Ft	0.944	1.639	2.917	5.111
Grid total depth	8.50	14.75	26.25	46.00

## 30 DEGREE SOIL

- Flat at Top and Bottom of Wall
- No Surcharge

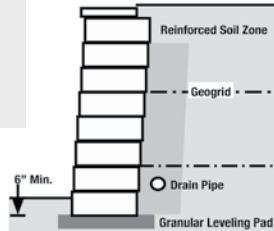

## GEOGRID PLACEMENT

- Grid is measured from the face of the wall.

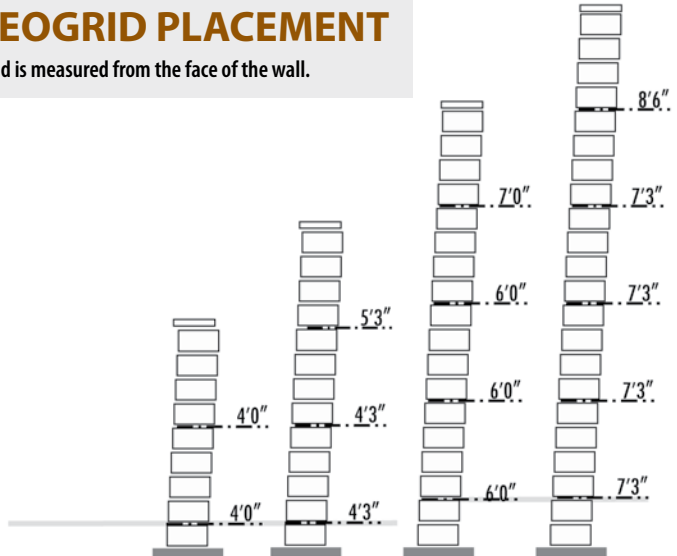

Exposed Hgt w/ cap	4'0"	6'0"	8'0"	10'0"
Amount Buried	6"	6"	1'0"	1'0"
Total Hgt w/ cap	4.5'	6.5'	9.0'	11.0'
Grid Sq Yd per Ln Ft	0.889	1.528	2.778	4.167
Grid total depth	8.00	13.75	25.00	37.50

See SRW's "Standard Engineering and How-To-Guide" for more information.

Need help figuring your project? Use our Stone Calculator online at [www.borgertproducts.com](http://www.borgertproducts.com).

## Geogrid Placement Tables - For walls up to 10' using Madera Block & SRW 5 Series Geogrid

The charts on the previous page are applicable for site soils when the friction angle is 26° - 30° degrees and the moist unit weight is 125 lbs. per cubic foot. That is typical for inorganic clays of low to medium plasticity. Site soils are assumed for the reinforced soil, backfill soil, and foundation soil.

1. Sample designs are to be used for preliminary design only when actual soil, site geometry, and surcharge conditions are conservatively represented by the assumptions of the tables in all situations. A qualified engineer using actual design conditions for the proposed site should perform the final as-built design.
2. Sample designs have been prepared exclusively for the use of SRW 5 Series Geogrid.
3. **MINIMUM FACTORS OF SAFETY:** 1.5 for internal reinforcement pullout and tensile overstress, 1.5 for external sliding, 2.0 for external overturning and bearing capacity. NO provision or analysis included for global stability or seismic design.
4. Sample designs require adequate drainage provisions for both the reinforced wall fill and retained backfill.
5. Geogrid must be one continuous piece from the face of the retaining wall block to the back of the reinforced soil mass. No splicing of geogrid. Geogrid must butt together at edges but must not be overlapped. Geogrid must be pulled taught and fastened before backfill is placed.
6. Follow the installation instructions that are supplied with the retaining wall system that you are purchasing. *(Which should include foundation preparation, block alignment, core filling of block, drainage rock placement, backfill placement, and compaction.)*
7. See your local building department for permitting requirements.
8. Each design is to be used up to the indicated height only. When the retaining wall exceeds that height a higher design shall be used.
9. When the retaining wall steps up at the bottom of the wall, bottom geogrid layers should be moved up with the steps and not dropped off until the next layer of geogrid is encountered.
10. Light traffic is auto or empty pickup truck loading. Any vehicle traffic or parking loads exceeding light traffic vehicle weights at the top of the retaining wall shall require a special site specific preliminary design.
11. If there is a slope at the bottom of the wall, additional embedment depth of the bottom courses and additional geogrid may be required.
12. If your site does not fit the above site configurations, call SRW Products at 800-752-9326 for a free site specific preliminary design.

**See SRW's "Standard Engineering and How-To-Guide" for more information.**

# ACCENTS

## BULLNOSE

ITEM		CODE	DIMENSIONS	BANDS	CUBES
<b>Bullnose</b>		<b>7BN</b>	3" x 12" x 2 <sup>3</sup> / <sub>8</sub> "	75 pcs 531#	300 pcs 2125# (4 bands)

### Bullnose Stock Colors

STOCK COLORS	CODE	STOCK COLORS	CODE	STOCK COLORS	CODE
<b>Chamois</b>	<b>06</b>	<b>Charcoal</b>	<b>08</b>	<b>Minnesota River</b>	<b>18</b>

*For best blend results, always select from multiple cubes.*

## BORGERT STEP UNIT

ITEM		CODE	DIMENSIONS	WEIGHT PER UNIT	UNITS PER PALLET	WEIGHT PER PALLET
<b>Borgert Step Unit</b>		<b>8SU</b>	18" x 48" x 6"	425#	6	2550#

### Borgert Step Unit Stock Colors

STOCK COLORS	CODE	STOCK COLORS	CODE	STOCK COLORS	CODE
<b>Iron Range</b>	<b>45</b>	<b>Limestone</b>	<b>30</b>	<b>Minnesota River</b>	<b>18</b>
<b>North Shore</b>	<b>40</b>	<b>Slate</b>	<b>32</b>	<b>Sterling Gray</b>	<b>05</b>

*For best blend results, always select from multiple cubes.*

**ATTENTION: TO PREVENT BREAKAGE OF STEP UNIT USE CARE WHEN HANDLING.**

Need help figuring your project? Use our Stone Calculator online at [www.borgertproducts.com](http://www.borgertproducts.com).

# STRASSEN® WALL PRECAST & ROUND FIRE PIT CAPS

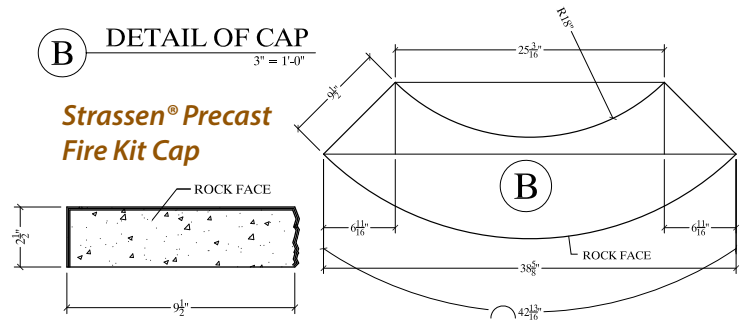
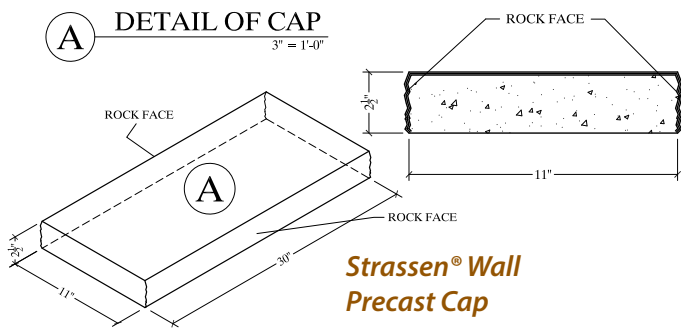

\*Precast caps & blocks are not fire rated.

## Strassen® Wall Precast & Round Fire Pit Cap Colors



ACCENT SOLID COLORS	CODE	ACCENT SOLID COLORS	CODE	ACCENT SOLID COLORS	CODE
<b>Brown</b> (Strassen precast cap color & round fire pit cap)	<b>04</b>	<b>Charcoal</b> (Strassen precast cap color & round fire pit cap)	<b>08</b>	<b>Limestone</b> (Strassen precast cap color & round fire pit cap)	<b>30</b>

See page 27 for weights and packaging.

### IMPORTANT NOTE ON FIRE RING CAPS:

There are no warranties, expressed or implied, on this product. When burning in the fire ring, leave a gap between the burning wood and the fire ring cap to allow heat to escape the fire. Failure to have an air buffer between the fire pit caps and the burning wood can result in heat stress cracks in the fire ring caps. Fire rings are for burning wood only. Burning other material may increase the fire temperature resulting in a higher risk for heat cracking.

## PRECAST PILLAR CAPS

ITEM	WEIGHT/UNIT	UNITS/PALLET	WEIGHT/PALLET
<b>Pillar Cap - Sloped Top or Flat - 24" x 24" x 2 1/4"</b> *Available with Rockface Edge or Smooth Edge   <b>5PCR</b> - Rockface Edge Sloped <b>5FCR</b> - Rockface Edge Flat <b>5PC</b> - Smooth Edge Sloped <b>5FC</b> - Smooth Edge Flat	145#	8	1080#

## Pillar Cap Stock Colors

STOCK COLORS	CODE	STOCK COLORS	CODE	STOCK COLORS	CODE
<b>Brown</b>	<b>04</b>	<b>Charcoal</b>	<b>08</b>	<b>Limestone</b>	<b>30</b>

# OTHER PRODUCTS & EQUIPMENT

## PAVE TECH EDGE RESTRAINT

ITEM	CODE	SIZE	PER BUNDLE CASE/BOX	UNITS PER PALLET
Rigid Edge - Bundle	5PE01	7'	12	84 FT
Flex Edge - Bundle	5PE02	7'	12	84 FT
Pave Edge - By the Pallet		7'	49	4116 FT
Mixed Pallet:				
- Flex		7'	25	2100 FT
- Rigid		7'	24	2016 FT

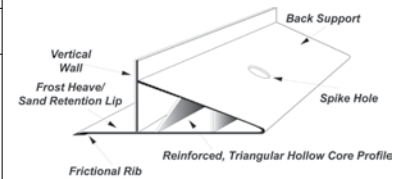
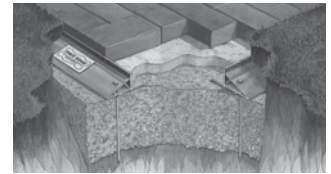

## LANDSCAPE SPIKES

ITEM	CODE	SIZE	PER BUNDLE CASE/BOX
Singles	5MSS1	10"	
Case Lot	5MS00	10"	150 (approximately)



## Adhesives / Bonds

ITEM	CODE	SIZE	PER BUNDLE CASE/BOX
SRW Adhesive - Case Lot	5MA02	10 oz.	12
SRW Adhesive - Single Tube	5MA02S	10 oz.	
SRW Adhesive - Case Lot	5MA04	28 oz.	12
SRW Adhesive - Single Tube	5MA04S	28 oz.	

This is the adhesive that the contractors ask for as "SRW." Professional strength adhesive for masonry, concrete, brick, block, pavers and other common landscaping materials.  
**NOTE: Works on wet or frozen surfaces.**



## Geotextile Fabrics - SS5 for Under Base

SRW Woven polypropylene geotextiles provide excellent puncture and tear resistant properties, along with high tensile strength. The primary use of wovens are for separation.

**Silt Film Wovens:** Use for soil separation and reinforcement over moderate sub-grades, under roadways, parking lots and residential streets. This fabric will improve the long-term performance of your project 50-70% and may save you as much as 30% in base materials costs.

ITEM	CODE
12.5 x 27 (Folded)	5MG50
12.5 x 54	5MG04
12.5 x 108	5MG51

**Features:**

- Easy Installation** - Conforms easily to the ground and offers good resistance to installation abuse.
- Versatile** - Chemically stable in a wide range of aggressive environments.
- Sizes** - Available in retail and large construction roll sizes



Need help figuring your project? Use our Stone Calculator online at [www.borgertproducts.com](http://www.borgertproducts.com).



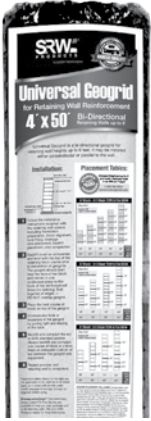

ITEM	CODE
Universal 4' x 50' Bi-directional for walls up to 6'	5MG60

## RETAINING WALL GEOGRID

SRW Geogrid is composed of high-molecular weight, high-tenacity multi-filament polyester yarns that are woven into a stable network placed under tension and coated with PVC.

## FEATURES

- Adds strength and longevity to your wall
- Easy to handle roll sizes
- Helps prevent premature wall failure
- Provides excellent stress transfer

Visit [SRWProducts.com](http://SRWProducts.com) for installation instructions



Visit [SRWProducts.com](http://SRWProducts.com) for installation instructions

## BENEFITS

- **Zero Haze** - Pavermate Z3 does not contain Portland, Fly Ash or Crushed Limestone, which are ingredients that cause hazing. That, along with our clear polymer technology sets you up for a haze free project, every time!
- **Zero Dust** - Specially mixed to bind polymers to sand particles and each other, which reduces fines, creating anti-dusting results.
- **Zero Problems** - Rain safe in 10 minutes. Fastest set up on the market helps in situations with unforeseen rain and weather.

## APPLICATIONS

- Paver Joints up to 2"
- Concrete Overlays
- Concrete Pavers
- Pool Decks & Patios
- Driveways & Walkways

## USER TIPS

1. Recommended for joints between 1/16" to 2" at intersecting points. Minimum joint depth of 1 1/2". Can be used for false joints.
2. Coverage is dependent on multiple factors including joint depth, width, compaction and paver type. Typical coverage is 55 - 75 sq. ft. per bag for narrow joints or 20 - 30 sq. ft. for larger joints.
3. Proper compaction is very important for obtaining optimal joint strength.
4. Irrigation systems should be turned off until polymeric sand has fully cured.
5. Test in a small discrete area. Do not use on pool copings. Not recommended for flagstone patios, clay pavers or wet/heavily shaded areas. Continuous dampness can prevent polymeric sand from curing properly.
6. Use SRW Paver Clean™, PW Paver Wash or EF Efflorescence cleaner prior to sealing. For best results, wait 28 days after installation before cleaning and sealing.

ITEM	CODE	WEIGHT	QTY
Pavermate Z3™ Granite	5TZ3G	50 lbs.	Bag (49/PLT)
Pavermate Z3™ Tan	5TZ3T	50 lbs.	Bag (49/PLT)

# Pave Tech® / Probst Equipment

## 5MP02 PaverADJUSTER™

(w/replacement blade) Designed to be used standing up, the **PaverADJUSTER™** is the easiest way to adjust bond lines.



## 5MP05 QuickDRAW™

Designed to mark the soldier courses. Unit glides along most edge restraints (like **PAVE EDGE®**) or the guide wheel rolls along curbs, walls, and more.



## 5MP08 PaverADJUSTER™ Blades

(set of 2 replacement blades)



## 5MP17 SlabGRABBER™

Works great on retaining wall blocks and slabs. 3 different sizes to accommodate a large range of products. The carrying capacity is 130 lbs, with an opening range of 4¼" - 24" depending on size.



## 5MP06 PaverCART™

Moves banded and non-banded pavers around the jobsite in a fraction of time all other methods require. If there is one tool you need, this is it. Save time and money by reducing needless labor hours!



## 5MP18 WallSPLITTER™

The **WallSPLITTER's** cutting height is ¾" to 12", making this extremely universal on all types of concrete and clay. Creates the same look and texture of a split-face without the needless chiseling one endures without a splitter. A large two-sided loading table works great for the largest of units, while tiltable on one side for undercuts. A floating upper blade ensures uniform contact, along with it being four-sided.

## 5MP01 PaverEXTRACTOR™

The professional's answer to paver removal. Why risk damaging surrounding pavers by using screwdrivers? The serrated spring steel tooth extract most pavers, including pavers without spacer bars.



## 5MP136 PaverSQUARE PRO™

A quick and easy way to establish 90° angles when starting to lay pavers. Lightweight stainless steel unfolds into a 48" x 68" layout square. When stored, dimensions are 3"W x 73"L.

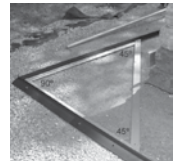

## 5MP10 PaverEXTRACTOR™ Blades

(set of 2 replacement blades)

## 5MP59 PaverSAVER UNI-MAT™

A universal (22" x 30") urethane rubber mat that can be trimmed to the size of almost any compactor plate. Designed to reduce damage to textured surface pavers, clay brick, natural stone, and paving slabs.



## 5MP146 PaverSCRIBE™

When marking pavers without a soldier course, the **PaverSCRIBE™** is an indispensable aid that not only reduces time needed for those difficult marking/cutting, but also results in uniform spacing for a more professional appearance.



## 5MP611 Hammer

EH3028 19" Wood Handle hammer with Blk/White Head & cast iron head housing. This hammer offers two striking surfaces, with interchangeable heads. They come standard with one black medium hard rubber head, and one white hard nylon head.



## 5MP42 KneeSEATS™

(set of 2)



## 5MP15 PaverPAW™

One handed option for the ever so popular larger pavers. Operating range: 6 - 10"



## 5MP42 MITE™ VS 110 volt

The ideal tool for handling all types of slabs safely, efficiently and ergonomically. The available "Long Handle Set" allows easier handling of larger (36 in+) slabs. Lifting bracket with safety chain is also available making it possible to attach to various construction equipment.



For a complete list of tools or to order please go to [www.pavetech.com](http://www.pavetech.com) or call 800.728.3832

# PRODUCT SPECIFICATION EF-FORTLESS



## EF Efflorescence Remover



### EF

Specialty Clean™ EF is a product which acts quickly to dissolve efflorescence (white mineral deposits) that dulls pavers. It can easily be applied to pavers, retaining walls, brick and masonry.

### FEATURES

- Dissolves mineral deposits
- Prepares surface for sealer application
- Restores natural paver color
- Contains no muriatic acid or hydrochloric acid

### COVERAGE

Up to 200 sq. ft. per gallon (18.58 sq. m. per 3.78 liters). Coverage may vary depending on surface and application.

### EASY 4-STEP PROCESS

1

#### PREP



- Thoroughly sweep surface of joint sand, dust, debris or loose material.
- Spot clean if needed with one of these SRW Specialty Clean products:  
**CD** = Cleaner & Degreaser  
**RE** = Rust Eliminator  
**MC** = Mold, Moss & Mildew Cleaner  
**OC** = Organic Stain Cleaner  
**TR** = Tar, Gum & Rubber Remover

2

#### WET



- Saturate surface & surrounding area thoroughly (including vegetation).
- Do not allow product to dry on surface. Re-spray if needed to keep area wet. A 2-person application is recommended.

3

#### APPLY



- Apply EF directly to surface with a sprinkler can. Do not dilute.
- With a stiff bristle brush, scrub area immediately & thoroughly.
- For large areas, work in 100–150 sq. ft. (9.29–13.94 sq. m.) sections.
- If working on an incline, start at the highest point, working in small sections. Scrub from bottom of section, pushing excess EF up over job.

4

#### RINSE



- Immediately rinse surface & surrounding areas (including vegetation) thoroughly with clean water until all traces of foam disappear.
- Repeat if necessary. Let dry.
- Wait at least 24 hours to apply SRW Paver Seal™ products.

### USER TIPS

- Wait 60-90 days for new pavers to cure before applying EF.
- Wear eye protection and rubber gloves when applying EF.
- Prolonged contact of cleaner on metal or other surfaces may result in etching or damage.
- Saturate vegetation before and after application of EF.
- **NOT FOR USE ON:**  
 » Sealed surfaces, wetcast or natural stone

### CLEAN-UP & STORAGE

Rinse off all equipment with clean water and let dry.

**KEEP FROM FREEZING.** Store container in a cool area with cap or lid firmly in place. Rinse off all equipment with clean water and let dry.

ITEM	CODE	WEIGHT	QTY
EF Efflorescence Remover	5ER	10 lbs.	Gallon (4 Gal/CTN)

# COLOR SELECTION GUIDE

	ADOBE	AUTUMN BLEND	BOULDER BLEND	BRONZE GRANITE	BROWN	BUFF	CHAMOIS	CHARCOAL	CLASSIC BRONZE	GOLDEN BROWN	GRAPHITE	GRAND CANYON	IRON RANGE	LIMESTONE	MESA	MINNESOTA RIVER	NORTH SHORE	PEWTER	SLATE	STERLING GRAY
Cobble Series™	Ⓛ	Ⓛ						Ⓛ				Ⓛ			Ⓛ	Ⓛ				Ⓛ
Additional Cobble (only 6x6, 6x9, ¾ & Large Circle)							Ⓛ	Ⓛ												
Holland Stone™	Ⓛ	Ⓛ			Ⓛ	Ⓛ						Ⓛ			Ⓛ	Ⓛ				Ⓛ
Holland Stone™ (80mm)							Ⓛ													
Bavaria II												Ⓛ			Ⓛ	Ⓛ				Ⓛ
Vavel II™												Ⓛ			Ⓛ	Ⓛ				Ⓛ
Cracovia							Ⓛ	Ⓛ		Ⓛ	Ⓛ		Ⓛ	Ⓛ	Ⓛ	Ⓛ				Ⓛ
Classic		Ⓛ													Ⓛ					Ⓛ
Bavaria												Ⓛ			Ⓛ	Ⓛ				Ⓛ
Additional Bavaria & Bavaria II (only 5x5, 6x9 & 5x11)							Ⓛ													
Vavel™												Ⓛ			Ⓛ	Ⓛ				Ⓛ
DrenaPave™															Ⓛ					Ⓛ
DrenaMontage™															Ⓛ					Ⓛ
BrükStone®															Ⓛ	Ⓛ				Ⓛ
Old Munich		Ⓛ										Ⓛ			Ⓛ					Ⓛ
Kastle Flats								Ⓛ												Ⓛ
Bulovar® & Bulovar® Max	Ⓛ								Ⓛ									Ⓛ	Ⓛ	
Strassen® Wall II							Ⓛ	Ⓛ							Ⓛ	Ⓛ				Ⓛ
Strassen® Wall Tumbled		Ⓛ					Ⓛ	Ⓛ				Ⓛ			Ⓛ	Ⓛ				Ⓛ
Strassen® Wall Precast Cap				Ⓛ			Ⓛ	Ⓛ				Ⓛ								
Madera Wall												Ⓛ			Ⓛ	Ⓛ				Ⓛ
Morteza Wall												Ⓛ			Ⓛ	Ⓛ				Ⓛ
Madera & Morteza Split Cap								Ⓛ				Ⓛ			Ⓛ	Ⓛ				Ⓛ
PanoMur® Wall (curved and straight)								Ⓛ							Ⓛ					Ⓛ
PanoMur® Split Cap								Ⓛ							Ⓛ					Ⓛ
Round Fire Pit Cap				Ⓛ			Ⓛ					Ⓛ								
Pillar Cap				Ⓛ			Ⓛ					Ⓛ								
Step Unit												Ⓛ	Ⓛ		Ⓛ	Ⓛ				Ⓛ
Bullnose							Ⓛ	Ⓛ							Ⓛ					

**For best blend results, always select from multiple cubes.**

**Selecting Colors:**  
Make final color selection from actual samples.

**Choosing Blends:**  
Borgert Products manufactures pavers and walls in various blend colors that consist of either two or three colors. When choosing a blend, it is important to keep in mind that some of the pavers will be dominant in one of the colors and some will be a combination of the colors that are in that particular blend. (i.e., Minnesota River is a blend consisting of Chamois, Brown & Charcoal - some pavers will be entirely Chamois, some entirely Brown, and some will be entirely Charcoal, and others will be a combination of two or three of these colors.)











**Colors are not limited. For special orders, call your Borgert representative.**

**Color selection subject to change without notice.**

**Not all products are stocked in Colorado.**



Need help figuring your project? Use our Stone Calculator online at [www.borgertproducts.com](http://www.borgertproducts.com).

# NON-STOCK PRODUCTS

STYLE		CODE	DIMENSIONS	CUBES
<b>Double Holland™</b> <b>8" x 8"</b> <i>*NOT SOLD BY THE BAND</i>		<b>4DH</b>	200mm x 200mm x 60mm Approximate 7 <sup>7</sup> / <sub>8</sub> " x 7 <sup>7</sup> / <sub>8</sub> " x 2 <sup>3</sup> / <sub>8</sub> " (PSF = 2.25 stones @ 28#)	94 SF 2632# (216 pcs)
<b>Holland Stone Square™</b> <b>12" x 12"</b> <i>*NOT SOLD BY THE BAND</i>		<b>4HQ</b>	300mm x 300mm x 60mm Approximate 11 <sup>7</sup> / <sub>8</sub> " x 11 <sup>7</sup> / <sub>8</sub> " x 2 <sup>3</sup> / <sub>8</sub> " (PSF = 1 Stone @ 28#)	112 SF 3136# (112 pcs)
<b>Holland II™</b> <b>4" x 8"</b> <i>*NOT SOLD BY THE BAND</i>			100mm x 200mm Approximate 3 <sup>7</sup> / <sub>8</sub> " x 7 <sup>7</sup> / <sub>8</sub> " (PSF = 4.5 stones @ 28#)	<b>4HT - 60mm Height</b> 94 SF 2632# (432 pcs) <b>4HT8 - 80mm Height</b> 64 SF 2272# (288 pcs)
<b>Holland Stone™ - 70mm</b> <b>4" x 8"</b> <i>*NOT SOLD BY THE BAND</i>		<b>4H7</b>	100mm x 200mm x 70mm Approximate 3 <sup>7</sup> / <sub>8</sub> " x 7 <sup>7</sup> / <sub>8</sub> " x 2 <sup>3</sup> / <sub>4</sub> " (PSF = 4.5 stones @ 32.5#)	80 SF 2600# (360 pcs)
<b>Plaza Rectangle™</b> <b>6" x 9"</b> <i>*NOT SOLD BY THE BAND</i>			160mm x 240mm Approximate 6 <sup>1</sup> / <sub>4</sub> " x 9 <sup>3</sup> / <sub>8</sub> " (PSF = 2.46 stones @ 28#)	<b>4PP - 60mm Height</b> 91.4 SF 2559# (225 pcs) <b>4PP8 - 80mm Height</b> 60.97 SF 2164# (150 pcs)
<b>Plaza Square™</b> <b>6" x 6"</b> <i>*NOT SOLD BY THE BAND</i>		<b>4TS</b>	160mm x 160mm x 60mm Approximate 6 <sup>1</sup> / <sub>4</sub> " x 6 <sup>1</sup> / <sub>4</sub> " x 2 <sup>3</sup> / <sub>8</sub> " (PSF = 3.69 stones @ 28#)	85.45 SF 2395# (315 pcs)
<b>Symetry®</b> <i>*NOT SOLD BY THE BAND</i>		<b>4SY</b>	60mm Height Approximate 4 <sup>3</sup> / <sub>8</sub> " x 10 <sup>3</sup> / <sub>4</sub> " x 2 <sup>3</sup> / <sub>8</sub> " (PSF = 3.04 stones @ 28#)	84 SF 2352# (256 pcs)
<b>Décor® Stone</b> <i>*NOT SOLD BY THE BAND</i>		<b>4DR</b>	140mm x 230mm x 60mm Approximate 5 <sup>3</sup> / <sub>8</sub> " x 9" x 2 <sup>3</sup> / <sub>8</sub> " (PSF = 3.5 stones @ 28#)	91.5 SF 2562# (320 pcs)
<b>ZigStone™</b> <i>*NOT SOLD BY THE BAND</i>		<b>4SR</b>	112 <sup>1</sup> / <sub>2</sub> mm x 225mm x 60mm Approximate 4 <sup>1</sup> / <sub>2</sub> " x 8 <sup>7</sup> / <sub>8</sub> " x 2 <sup>3</sup> / <sub>8</sub> " (PSF = 3.6 stones @ 28#)	87.5 SF 2450# (315 pcs)
<b>Cobble™ - 80mm</b> <b>6" x 6"</b> <i>*NOT SOLD BY THE BAND</i>		<b>4TC8</b>	160mm x 160mm x 80mm Approximate 6 <sup>1</sup> / <sub>4</sub> " x 6 <sup>1</sup> / <sub>4</sub> " x 3 <sup>1</sup> / <sub>8</sub> " (PSF = 3.69 stones @ 35.5#)	56.94 SF 2021# (210 pcs)
<b>Cobble™ - 80mm</b> <b>6" x 9"</b> <i>*NOT SOLD BY THE BAND</i>		<b>4PC8</b>	160mm x 240mm x 80mm Approximate 6 <sup>1</sup> / <sub>4</sub> " x 9 <sup>3</sup> / <sub>8</sub> " x 3 <sup>1</sup> / <sub>8</sub> " (PSF = 2.46 stones @ 35.5#)	60.94 SF 2163# (150 pcs)



# NON-STOCK PERMEABLE PRODUCTS

STYLE		CODE	DIMENSIONS	CUBES
<b>Superior Interloc</b> - NOT SOLD BY THE BAND		<b>40L</b>	(PSF = 1.76 stones @ 35.5#) Layer is 42" x 47.5" <i>NOTE: Mold configured for mechanical installation.</i> Cobble face or Standard Bevel	81.6 SF 2897#
<b>DrenaPave™</b> <b>80mm - Machine Lay</b> - NOT SOLD BY THE BAND		<b>4FPH</b>	5" x 10" x 31/8" @ 35.5# SF (90° Herringbone Pattern) <i>NOTE: Mold configured for mechanical installation.</i>	72.6 SF 2577# (258 pcs)

## NON-STOCK ITEMS: PLEASE CALL FOR QUOTE, LEAD TIME, AND ORDER REQUIREMENTS.

We guarantee 3 weeks delivery on all our special orders.  
 All special orders are full cube quantities only.

*NOTE: 3 color blends may require some hand mixing for a better blending of color.*



Need help figuring your project? Use our Stone Calculator online at [www.borgertproducts.com](http://www.borgertproducts.com).



# OUTDOOR FIREPLACE UNITS

Outdoor Fireplace Units

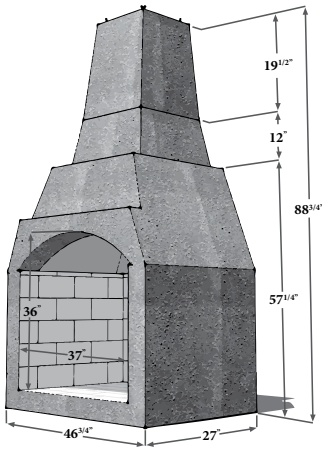

**King Arthur - 46"**

2065#

**5FPA**

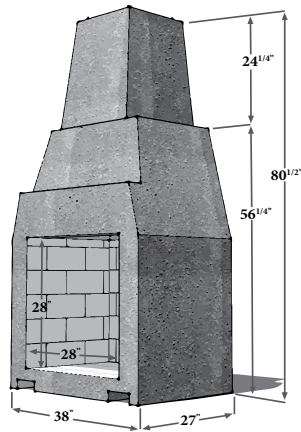

**Guinevere - 38"**

1698#

**5FPG**

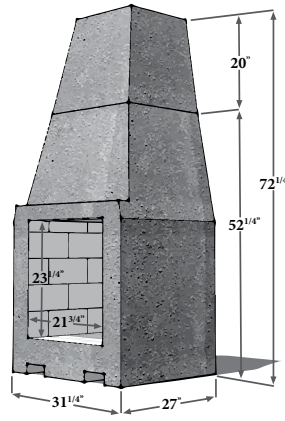

**Camlann - 31"**

1297#

**5FPC**

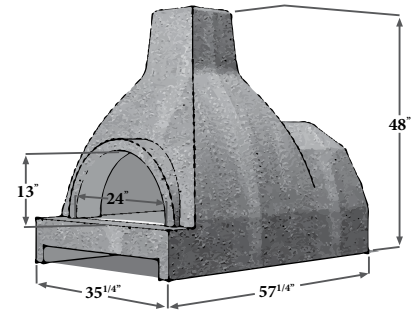

**Lancelot Outdoor Oven**

2000#

**5FPL**



**KING OF HEARTH'S**

OUTDOOR FIREPLACES & OVENS

- Units must be veneered with brick, stone, or Borgert Strassen Wall. Units include fire brick already installed and forking points for ease of setting in place with machine.

- Stress cracks in fireplaces and ovens are micro fractures that are a normal occurrence and do not affect the structural integrity of the unit, nor are grounds for rejection.

- Lancelot oven must be veneered with high density insulation, meshed and scratch coated to ensure a good bond with the veneer.

- All Units must have spark protector with solid top to keep water out, not included.

[www.TheKingofHearths.com](http://www.TheKingofHearths.com)

ITEM		CODE	DIMENSIONS	WEIGHT PER UNIT
Side Wood Storage Box		<b>5FSB</b>	36"H x 26"W x 26"D	260#

	KING ARTHUR	GUINEVERE	CAMLANN	LANCELOT	SIDE BOX
WEIGHT	2065#	1698#	1297#	2000#	260#
ANGLE IRON PIECE	48"	32"	31"	N/A	N/A
STONE VENEER	63 SF	46 SF	28 - 32 SF	26 - 30 SF	12 SF In/Out
LINEAR FOOT CORNERS	36	28	24	18	36 (Corners may vary)
SPARKER CAP MOUNT SIZE	13" x 13"	13" x 13"	13" x 13"	9" x 9"	N/A

# OUTDOOR FIREPLACE INSTALLATION & OPERATION

## A) ITEMS TO CONSIDER BEFORE INSTALLATION

The outdoor wood fireplaces constructed by The King of Hearths are a very high quality precast fireplace meant to enhance your outdoor living. They are not meant to be used inside a roofed area or building. Clearances to combustible materials are a major consideration. The stack of your fireplace is equipped to accept a chimney cap. **A cap with a spark arrestor is required.** There should be no combustible materials within 8 feet of the cap. The front of the fireplace opening requires a minimum of a 4 foot area where there should be no combustible materials. This includes items as wood decking, furniture and the like. Look for items such as power lines and trees in your yard area to make sure you have a safe clearance.

## B) PAD REQUIREMENTS

Your King of Hearths outdoor fireplace is constructed from a high strength light weight concrete. Because of this it may not be necessary to pour a pad to place your fireplace. Because the fireplace itself does not need assembly or to be mortared together a traditional frost foundation may not be required. You will need to remove all organic material (plant matter and topsoil) under your slab or hearth. That material needs to be replaced with gravel material and then compacted for support similar to what is done in preparation for proper sidewalk or driveway installations. Minimum pad dimensions are:

*King Arthur 50 inches wide by 40 inches deep*  
*Guinevere 42 inches wide by 32 inches deep*  
*Camlann 35 inches wide by 30 inches deep*

The pad should be poured a minimum of 6 inches deep. A rebar mat needs to be installed in a checkerboard fashion with 12 inch centers. This will keep the pad from splitting and putting undue pressure on the fireplace. If using one of our hearths it will only be necessary to level the hearth. In the event you are using a sidebox it will be necessary to enlarge the pad width by 24 inches. Pads should cure for 7 days before placement of your fireplace.

## C) FIREPLACE PLACEMENT

Once your pad or hearth installation is complete you can place your fireplace. Remove the stack from firebox. Your fireplace will come on a sturdy pallet in order to safely get the fireplace close to its final placement. It is not recommended to remove the fireplace from the pallet until it is placed next to the slab or hearth. The pallet will ensure proper weight displacement of the fireplace when coming across rough terrain. On the rear of the firebox there will be 2 fork pockets to lift the fireplace from its pallet and place onto the slab or hearth. It is advisable to center the fireplace on your slab or hearth for equal weight distribution. The stack needs to be placed at this point. Make sure it is centered on the opening in the top of the firebox. It is not necessary to mortar the stack. When you complete your facing with cultured stone, cultured brick or stucco it will lock in and seal your stack. The King Arthur has a 2 piece stack to accommodate the larger firebox.

## D) CONDITIONING YOUR FIREPLACE

It is recommended at this point before the facing is applied to build a few small fires. Make sure you have a proper chimney cap installed. Your King Of Hearths fireplace already has the firebrick installed. You can burn right on the bottom of the fireplace or install a log grate if you wish. This preburn is recommended to temper the unit. All materials including concrete will react to heat. This process will help bring the materials to a near final rest before the facing is applied. Your fireplace is meant to burn wood. Burning garbage, wood treated with preservatives or other materials can create temperatures much hotter than wood. In other words protect your investment. **NEVER** use gasoline or diesel fuel to start your fireplace. The preferred method would be using cardboard or kindling for starter.

## E) FINISHING YOUR FIREPLACE

Your King Of Hearths fireplace is left purposely with a semi rough surface. For best results mesh and scratch coat the surface to ensure a good bond between the unit and your finish material, whether it be cultured material or natural stone facing or stucco. It is recommended to leave a small gap of a quarter inch between the bottom of the fireplace veneer and pad. The reason for this is to prevent your facing from contacting the hearth or slab during the months when some movement can take place. Your King Of Hearths dealer will be able to make proper recommendations for your application. In the event you select to install one of our sideboxes with your fireplace you will notice that the height is slightly higher than the flat part of the firebox. This is done intentionally to ensure that a proper slope is installed in the veneer applied to prevent water and or ice pooling where the 2 precast units join. It is not necessary to anchor the sidebox to the firebox. The weight of the sidebox and the locking done by the veneer makes this not needed.

## F) WARNING

**BEFORE YOU START ANY FIRE, MAKE SURE THE BURNING AREA IS COMPLETELY DRY. SPARK ARRESTOR IS REQUIRED BEFORE STARTING A FIRE.**

Need help figuring your project? Use our Stone Calculator online at [www.borgertproducts.com](http://www.borgertproducts.com).

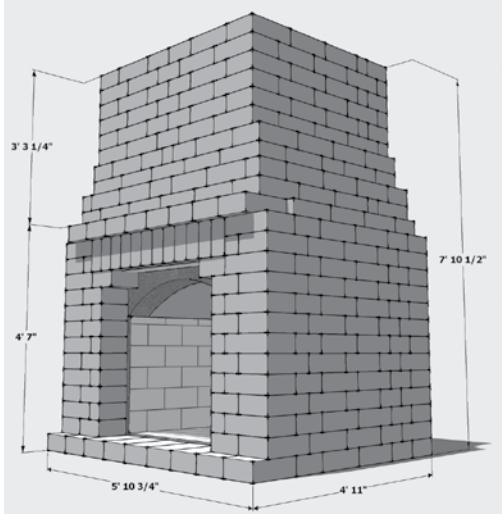

By Layers in Plan View

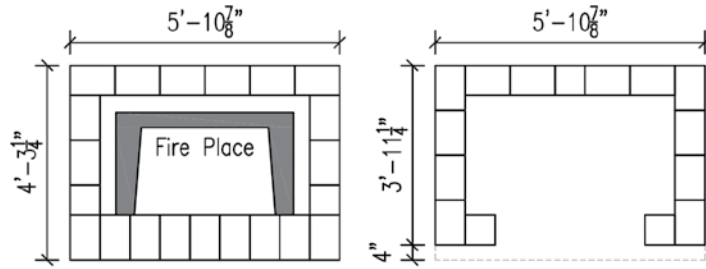

- |                |                |
|----------------|----------------|
| Layer 1        | Layer 2        |
| 19 - 12"x8"x4" | 12 - 12"x8"x4" |
| 2 - 8"x8"x4"   | 3 - 8"x8"x4"   |
| 0 - 4"x8"x4"   | 0 - 4"x8"x4"   |

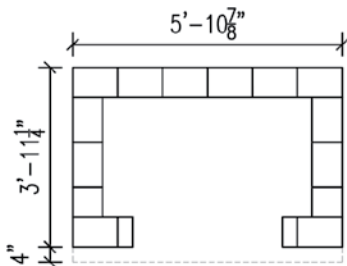

- Layer 3
- 12 - 12"x8"x4"
  - 2 - 8"x8"x4"
  - 2 - 4"x8"x4"

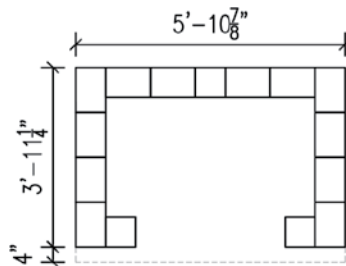

- Layer 4
- 12 - 12"x8"x4"
  - 3 - 8"x8"x4"
  - 0 - 4"x8"x4"

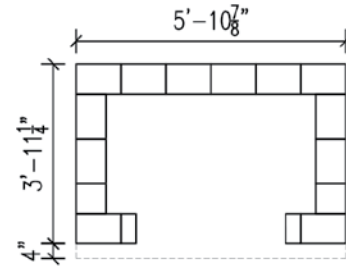

- Layer 5
- 12 - 12"x8"x4"
  - 2 - 8"x8"x4"
  - 2 - 4"x8"x4"

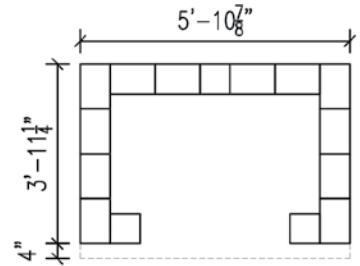

- Layer 6
- 12 - 12"x8"x4"
  - 3 - 8"x8"x4"
  - 0 - 4"x8"x4"

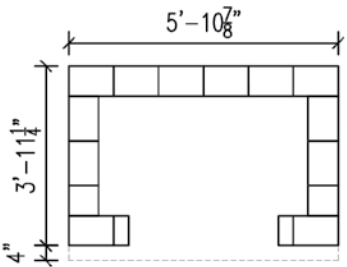

- Layer 7
- 12 - 12"x8"x4"
  - 2 - 8"x8"x4"
  - 2 - 4"x8"x4"

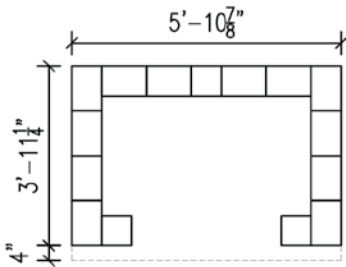

- Layer 8
- 12 - 12"x8"x4"
  - 3 - 8"x8"x4"
  - 0 - 4"x8"x4"

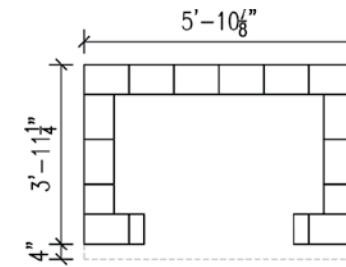

- Layer 9
- 12 - 12"x8"x4"
  - 2 - 8"x8"x4"
  - 2 - 4"x8"x4"

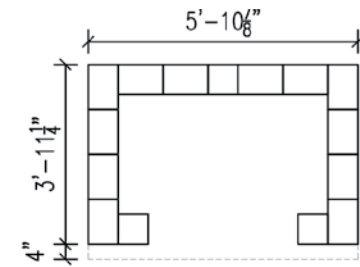

- Layer 10
- 12 - 12"x8"x4"
  - 3 - 8"x8"x4"
  - 0 - 4"x8"x4"

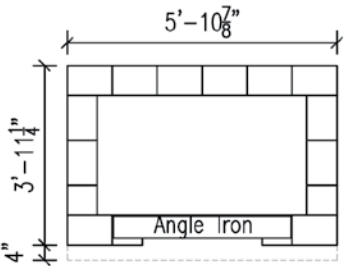

- Layer 11
- 12 - 12"x8"x4"
  - 4 - 8"x8"x4"
  - 0 - 4"x8"x4"

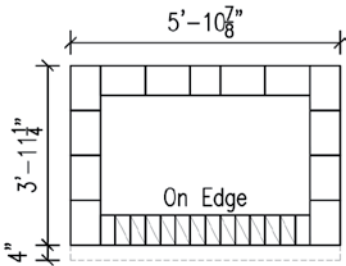

- Layer 12
- 12 - 12"x8"x4"
  - 13 - 8"x8"x4"
  - 2 - 4"x8"x4"

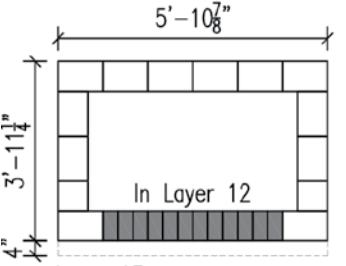

- Layer 13
- 12 - 12"x8"x4"
  - 2 - 8"x8"x4"
  - 0 - 4"x8"x4"

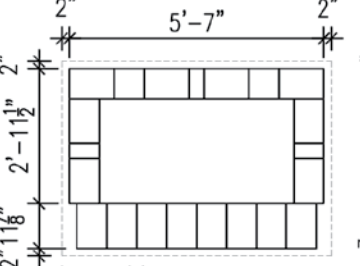

- Layer 14
- 16 - 12"x8"x4"
  - 2 - 8"x8"x4"
  - 3 - 4"x8"x4"

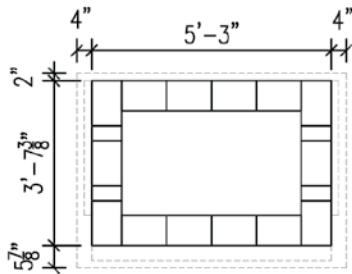

Layer 15  
 14 - 12"x8"x4"  
 0 - 8"x8"x4"  
 4 - 4"x8"x4"

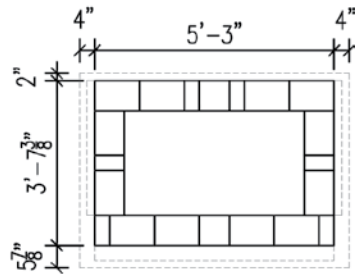

Layer 16  
 12 - 12"x8"x4"  
 2 - 8"x8"x4"  
 6 - 4"x8"x4"

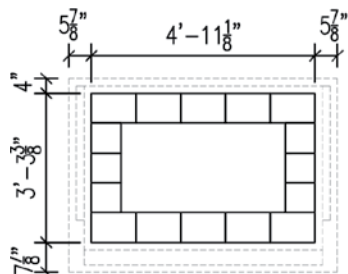

Layer 17  
 10 - 12"x8"x4"  
 6 - 8"x8"x4"  
 0 - 4"x8"x4"

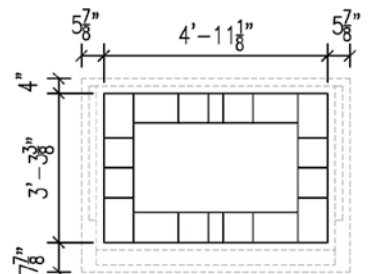

Layer 18  
 8 - 12"x8"x4"  
 8 - 8"x8"x4"  
 2 - 4"x8"x4"

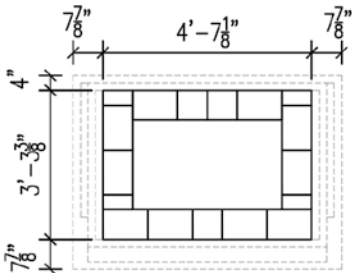

Layer 19  
 10 - 12"x8"x4"  
 3 - 8"x8"x4"  
 4 - 4"x8"x4"

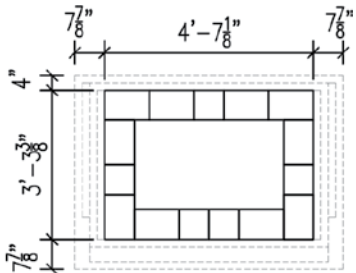

Layer 20  
 10 - 12"x8"x4"  
 5 - 8"x8"x4"  
 0 - 4"x8"x4"

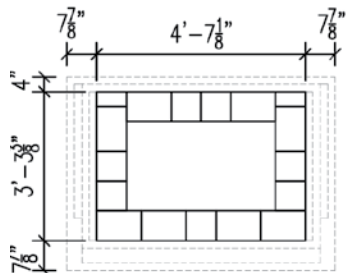

Layer 21  
 8 - 12"x8"x4"  
 7 - 8"x8"x4"  
 2 - 4"x8"x4"

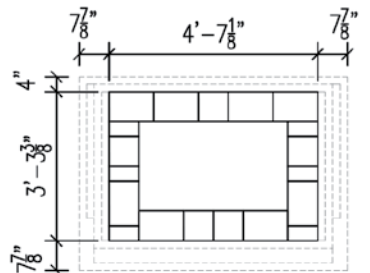

Layer 22  
 8 - 12"x8"x4"  
 5 - 8"x8"x4"  
 6 - 4"x8"x4"

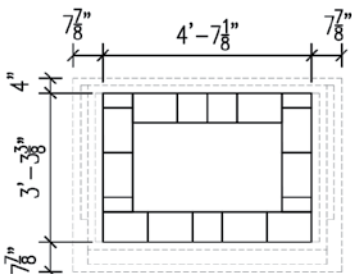

Layer 23  
 10 - 12"x8"x4"  
 3 - 8"x8"x4"  
 4 - 4"x8"x4"

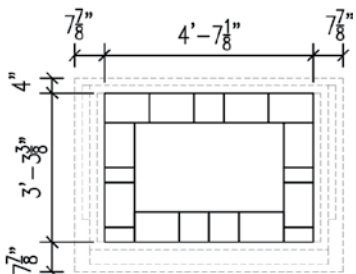

Layer 24  
 10 - 12"x8"x4"  
 3 - 8"x8"x4"  
 4 - 4"x8"x4"

**Total Count**

- 279 - Strassen Wall Pallet A (4"H x 12"L x 8"D)
- 88 - Strassen Wall Pallet B (4"H x 8"L x 8"D)
- 45 - Strassen Wall Pallet C (4"H x 4"L x 8"D)

**NOTE: The dimensions shown are approximate. Due to possible variations with the fireplace insert, positioning of the Strassen® Wall may have to be adjusted, or cut to fit.**

Need help figuring your project? Use our Stone Calculator online at [www.borgertproducts.com](http://www.borgertproducts.com).

# 38" Guinevere Outdoor Fireplace Layout Guide - (Builds using Strassen® Wall)

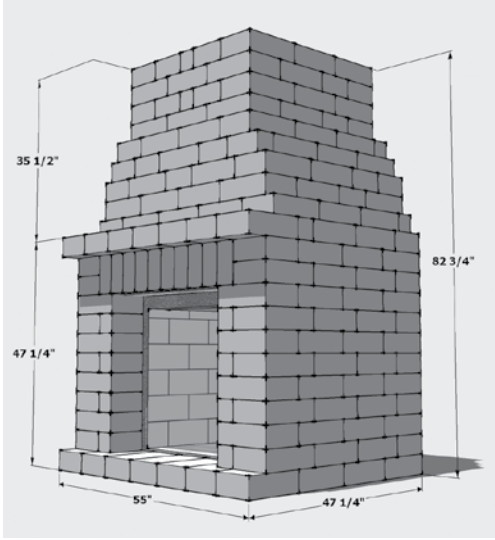

## By Layers in Plan View

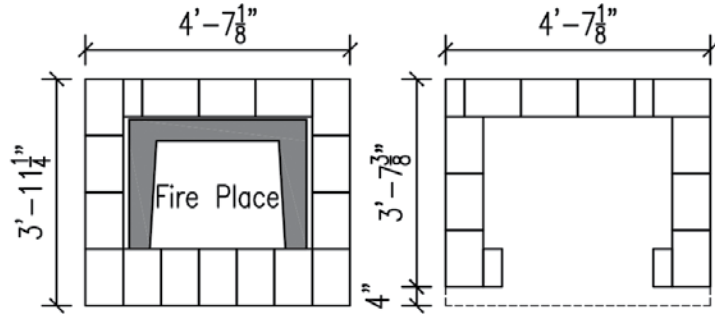

Layer 1

- 16 - 12"x8"x4"
- 0 - 8"x8"x4"
- 4 - 4"x8"x4"

Layer 2

- 10 - 12"x8"x4"
- 0 - 8"x8"x4"
- 4 - 4"x8"x4"

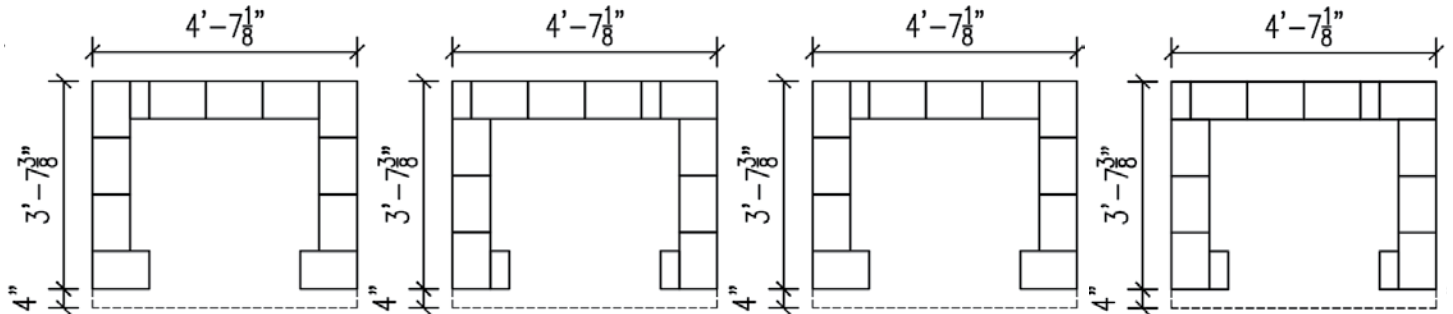

Layer 3

- 11 - 12"x8"x4"
- 0 - 8"x8"x4"
- 1 - 4"x8"x4"

Layer 4

- 10 - 12"x8"x4"
- 0 - 8"x8"x4"
- 4 - 4"x8"x4"

Layer 5

- 11 - 12"x8"x4"
- 0 - 8"x8"x4"
- 1 - 4"x8"x4"

Layer 6

- 10 - 12"x8"x4"
- 0 - 8"x8"x4"
- 4 - 4"x8"x4"

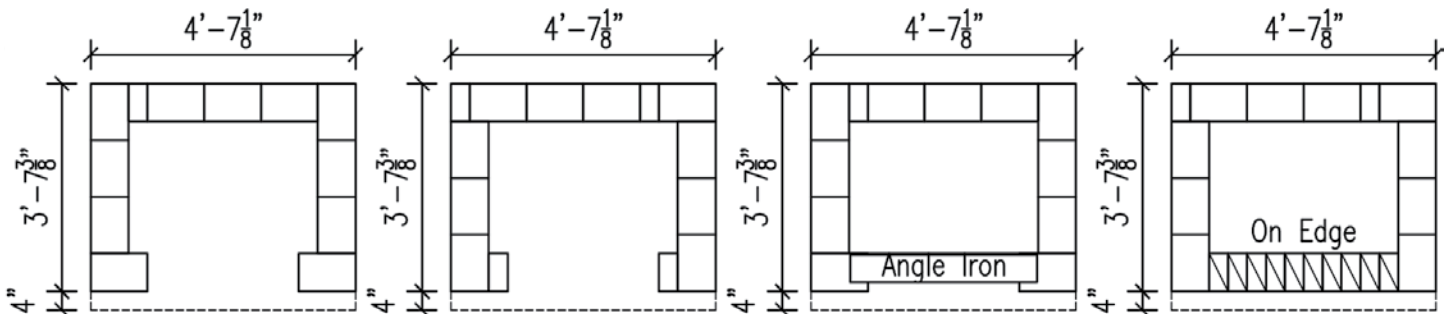

Layer 7

- 11 - 12"x8"x4"
- 0 - 8"x8"x4"
- 1 - 4"x8"x4"

Layer 8

- 10 - 12"x8"x4"
- 0 - 8"x8"x4"
- 4 - 4"x8"x4"

Layer 9

- 11 - 12"x8"x4"
- 0 - 8"x8"x4"
- 1 - 4"x8"x4"

Layer 10

- 10 - 12"x8"x4"
- 10 - 8"x8"x4"
- 2 - 4"x8"x4"



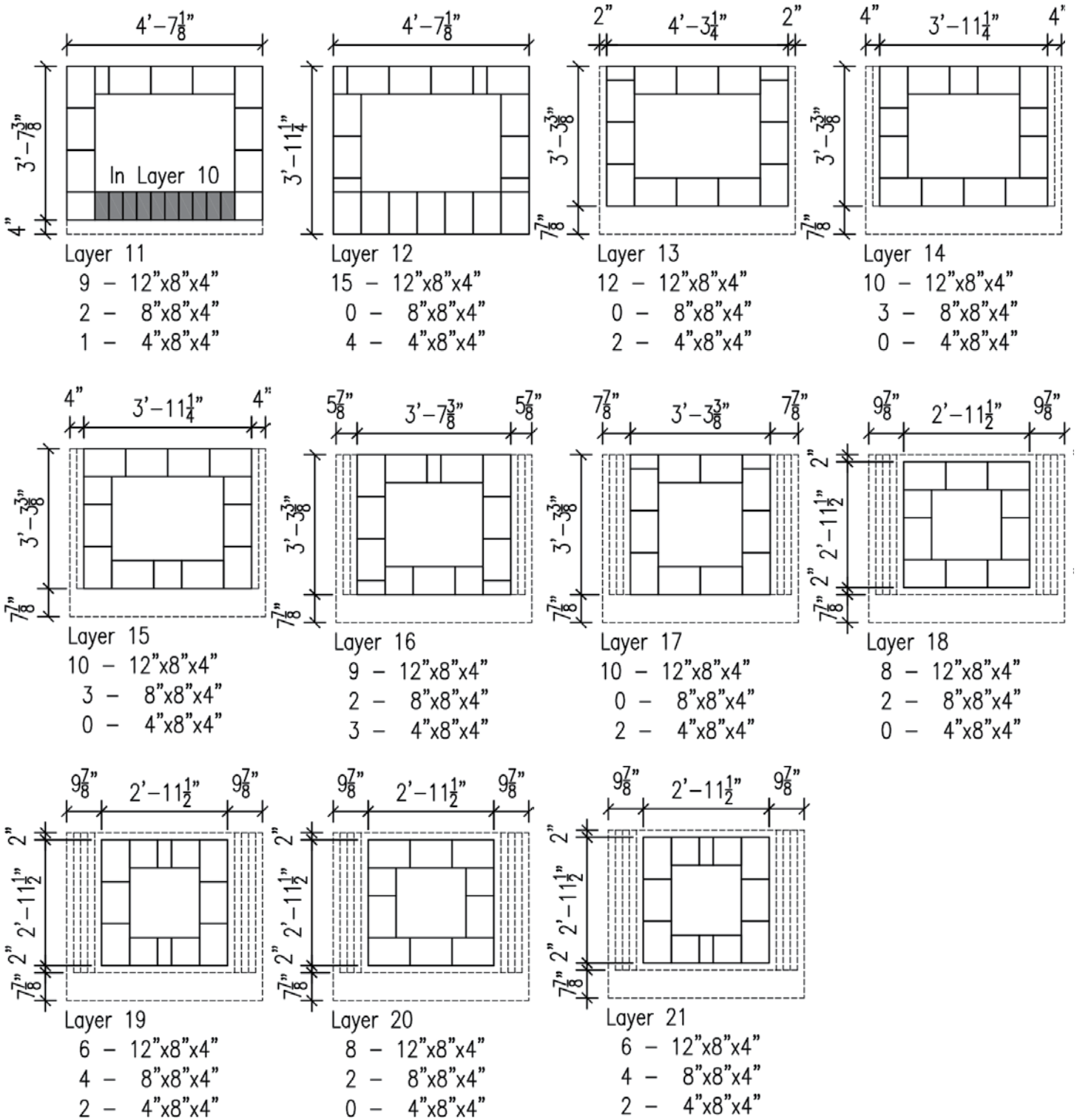

**Total Count**

- 213 - Strassen Wall Pallet A (4"H x 12"L x 8"D)
- 32 - Strassen Wall Pallet B (4"H x 8"L x 8"D)
- 39 - Strassen Wall Pallet C (4"H x 4"L x 8"W)

**NOTE: The dimensions shown are approximate. Due to possible variations with the fireplace insert, positioning of the Strassen® Wall may have to be adjusted, or cut to fit.**

Need help figuring your project? Use our Stone Calculator online at [www.borgertproducts.com](http://www.borgertproducts.com).



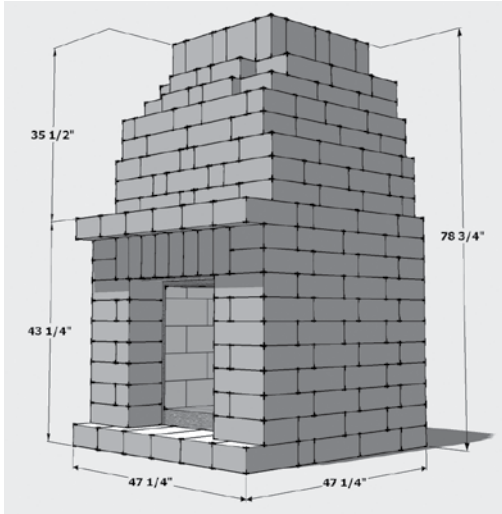

By Layers in Plan View

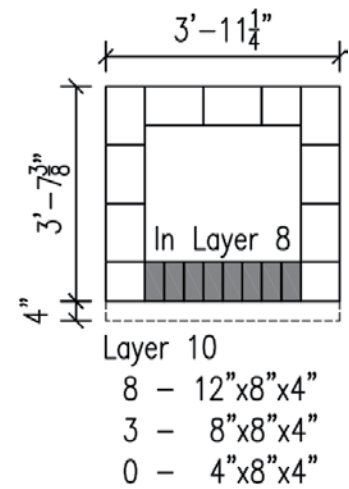
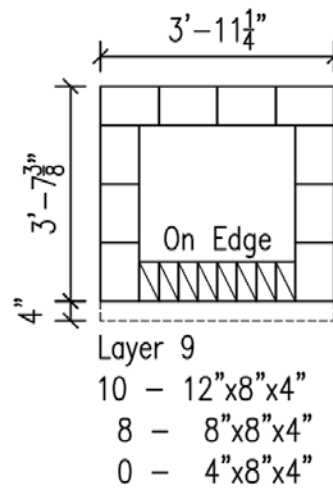
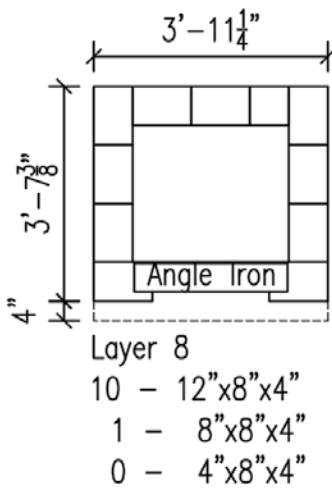
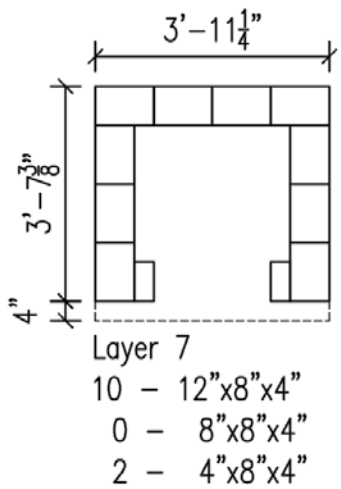
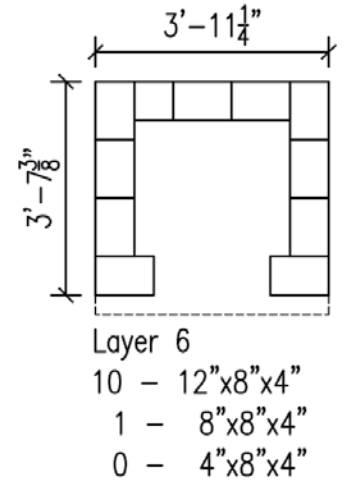
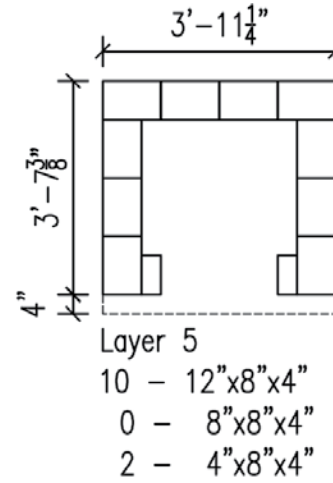
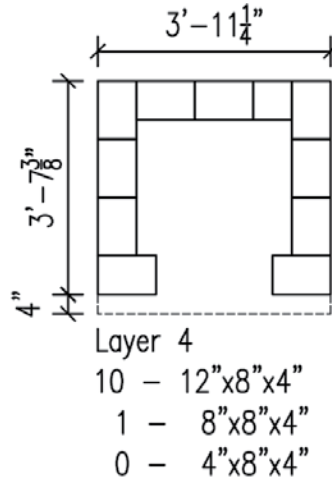
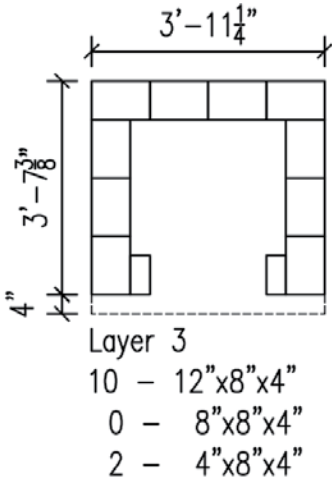
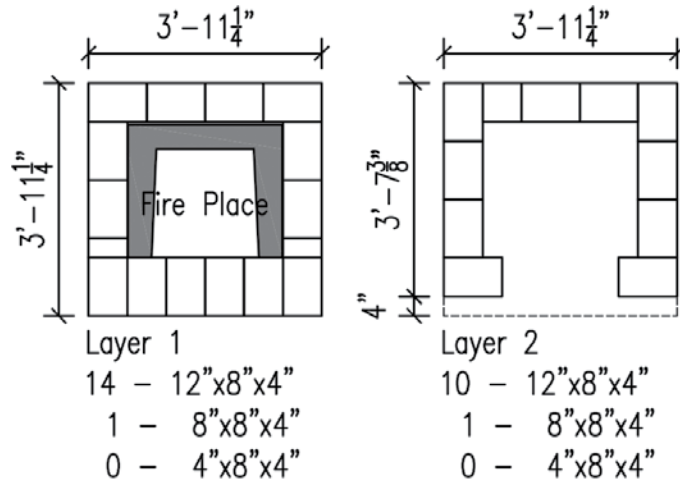

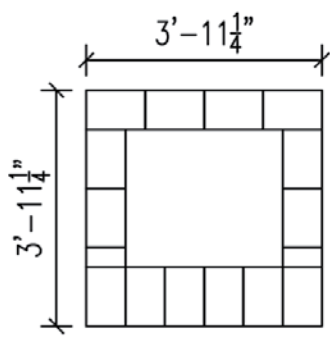

Layer 11  
 14 - 12"x8"x4"  
 0 - 8"x8"x4"  
 2 - 4"x8"x4"

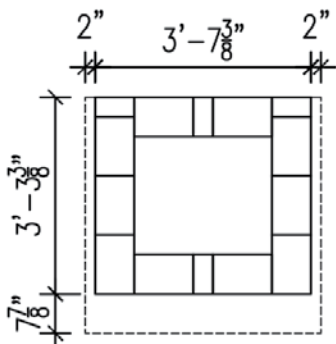

Layer 12  
 10 - 12"x8"x4"  
 0 - 8"x8"x4"  
 4 - 4"x8"x4"

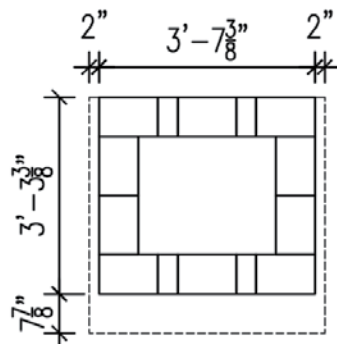

Layer 13  
 10 - 12"x8"x4"  
 0 - 8"x8"x4"  
 4 - 4"x8"x4"

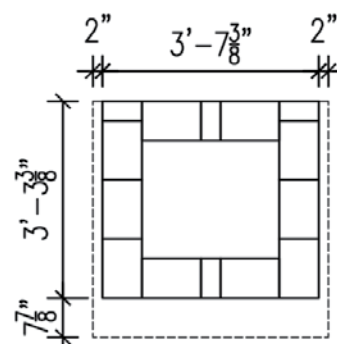

Layer 14  
 10 - 12"x8"x4"  
 0 - 8"x8"x4"  
 4 - 4"x8"x4"

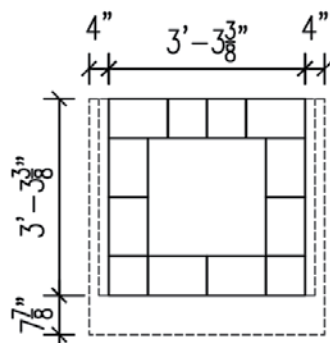

Layer 15  
 8 - 12"x8"x4"  
 4 - 8"x8"x4"  
 0 - 4"x8"x4"

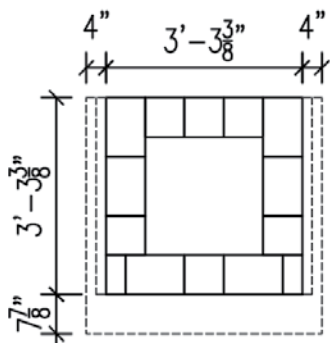

Layer 16  
 6 - 12"x8"x4"  
 6 - 8"x8"x4"  
 2 - 4"x8"x4"

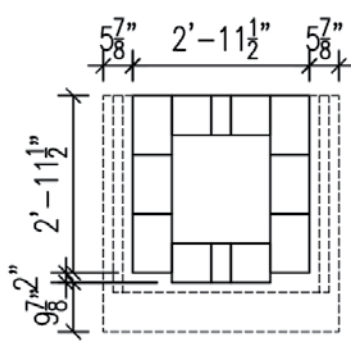

Layer 17  
 6 - 12"x8"x4"  
 4 - 8"x8"x4"  
 2 - 4"x8"x4"

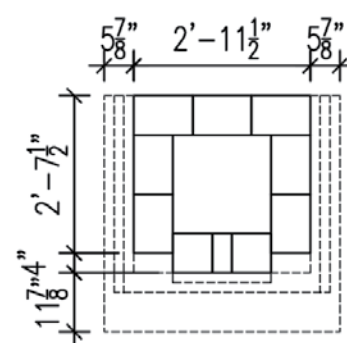

Layer 18  
 7 - 12"x8"x4"  
 2 - 8"x8"x4"  
 1 - 4"x8"x4"

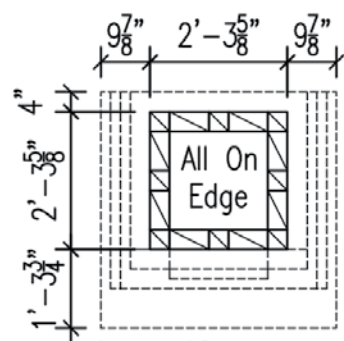

Layer 19  
 0 - 12"x8"x4"  
 8 - 8"x8"x4"  
 8 - 4"x8"x4"

Total Count  
 173 - Strassen Wall Pallet A (4"H x 12"L x 8"D)  
 39 - Strassen Wall Pallet B (4"H x 8"L x 8"D)  
 35 - Strassen Wall Pallet C (4"H x 4"L x 8"W)

**NOTE: The dimensions shown are approximate. Due to possible variations with the fireplace insert, positioning of the Strassen® Wall may have to be adjusted, or cut to fit.**

Need help figuring your project? Use our Stone Calculator online at [www.borgertproducts.com](http://www.borgertproducts.com).

# MATHEMATICAL FORMULAS

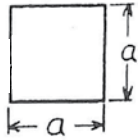

Area of a square =  $a \times a$

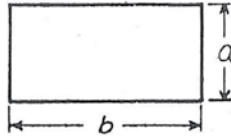

Area of a rectangle =  $a \times b$

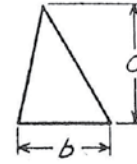

Area of a Triangle =  $\frac{a \times b}{2}$

Equilateral triangles  
 $a = .866 \times b$   
 Area =  $\frac{.866 \times b \times b}{2}$

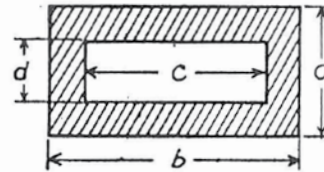
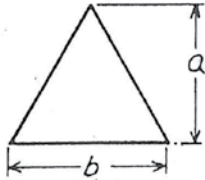

Area of a hollow rectangle =  $(a \times b) - (d \times c)$

## Circles

Circumference equals  $3.1416 \times D$

Diameter equals  $\frac{\text{Circumference}}{3.1416}$

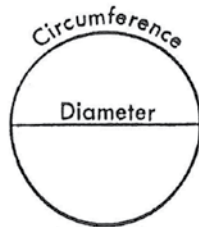

Area equals  $1.1416 (D \times D)$  or  $3.1416 R^2$  or  $.7854 D^2$  or  $.0796 (\text{circumference})^2$

Length of arc equals number of degrees  $\times$  diameter  $\times$  0.008727

To find side of an inscribed square multiply diameter by 0.7071 or multiply circumference by 0.2251 or divide circumference by 4.4428

The side of inscribed cube equals radius of sphere  $\times$  1.1547

To find side of an equal square multiply diameter by .8862

**Square:** The thickness multiplied by 1.155 equals diameter of its circumscribing circle

**Hexagon:** The thickness multiplied by 1.155 equals diameter of the circumscribing circle

**Octagon:** The thickness multiplied by 1.082 equals the diameter of the circumscribing circle

A side of a square multiplied by 4.443 equals circumference of its circumscribing circle; multiplied by 1.128 equals diameter of a circle of equal area multiplied by 3.547 equals circumference of a circle of equal area.

Area of a Parallelogram = Base  $\times$  Altitude

Area of a Trapezoid =  $\frac{1}{2}$  the sum of the parallel sides  $\times$  perpendicular height

Need help figuring your project? Use our Stone Calculator online at [www.borgertproducts.com](http://www.borgertproducts.com).

# NOTES

Notes

A large grid of graph paper for taking notes, consisting of 20 columns and 30 rows of small squares.

## THE BEST SYSTEM. THE BEST VALUE.

### DURABILITY

The industry standards for Interlocking Concrete Pavers are 8,000 psi and no more than 5% absorption. Borgert pavers exceed these standards giving them an excellent wearing course. The combination of high psi, low absorption and the addition of color throughout means **QUALITY** pavers that will last for years to come.

### FLEXIBLE SYSTEM

Bedding sand worked up between the pavers when they are compacted creates the “**INTERLOCK**”, thus a flexible pavement that is resistant to heaving in freeze/thaw conditions. If there is settling in the pavement it can be easily repaired by taking up the pavers reworking the base and putting the same pavers back in place – no unsightly patchwork.

### KEY TO SUCCESSFUL INSTALLATION

As with any pavement, a proper **BASE** is critical to the performance of the pavement. With Interlocking Concrete Pavement, the difference is there needs to be an **EDGE RESTRAINT**.

Permeable Interlocking Concrete Pavement is the same principal with the exception of the type of paver and the base is open graded aggregates.

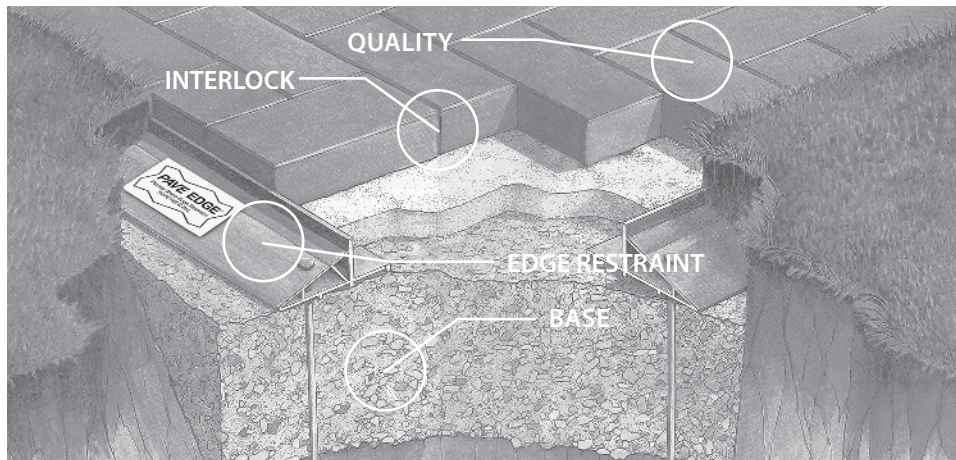

## BORGERT TECHNICAL SCHOOL

In support of our industry, Borgert created the Borgert Technical School (BTS) Installer Certification Course. The two day course includes hands-on training which makes it the best technical school in North America. We offer classes in both Interlocking Concrete Pavement (ICP) and Permeable Interlocking Concrete Pavement (PICP) installation for residential applications. The contractors who attend the course(s) are given a test which is administered by a third party. All passing attendees are given a certificate and listed on our website. Go to [borgertproducts.com](http://borgertproducts.com) for the current listing.



# WHAT YOU SHOULD KNOW ABOUT INTERLOCKING CONCRETE PAVEMENT

---

## MAINTAIN

Borgert pavers provide a durable yet decorative pavement - two big pluses. Like anything that is for outdoor use, they require a little care and maintenance. Clean pavement with a mild soap in the fall and spring or use cleaners specifically made for concrete pavers. Check with Borgert Products or your hardscape supplier for what products they recommend. Consider sealing driveways for more protection from street deicing chemicals.

## EFFLORESCENCE

A white haze known as efflorescence is a natural occurring process in concrete. Technically known as calcium hydroxide, it can come from a number of sources and appears as a white film when carried to the surface by moisture. It may appear randomly or in certain areas and is more pronounced on darker colors. The good news is efflorescence does not affect longevity or structural integrity of the pavers. Although unsightly, in many cases it is scoured off during installation when compacting the pavers. It can also be removed using specialty cleaners, made for interlocking concrete paving stones. Otherwise, it will typically lessen or dissipate over time with rain, snow and wear. Because efflorescence can be a natural by-product of cement hydration, its presence is not indicative of a flawed or defective product. Efflorescence cannot be prevented, so as with all other manufacturers, this condition is not a warranty issue.

## POLYMERIC HAZE

Interlocking concrete pavement (ICP) does not require a jointing material other than sand. Poly haze can happen if it is not used properly and should not be confused with efflorescence. Since the use of poly sand is not an installation requirement, Borgert Products accepts no responsibility in the event of hazing. We suggest you contact your contractor or the manufacturer of the polymeric sand for their suggestions concerning their products.

## SNOW, ICE AND DEICERS

Our pavers and walls are more than beautiful. They have the durability to withstand the harsh winters of the Midwest and, when properly installed, snow removal is no problem...either by shovel, snow blower or plow.

Our pavers have a surface that is slip and skid resistant even when wet. Ice, on the other hand, can be slippery and common sense should be used to prevent slips and falls. We recommend sand for traction, as it can be applied liberally and as needed. Clean, untreated sand has no corrosive effect on concrete pavers and it can be swept into the paver joints or removed by conventional sweeping or vacuuming.

Concrete pavers are robust in resisting the effects of deicing chemicals. We have manufactured pavers that have been exposed to salt for over 40 years! Nevertheless, deicing chemicals can be harmful to the pavers. If using a deicer, the ICPI recommends a NaCl sodium chloride. We recommend against the use of other types, including products that contain a blend of chemicals. Pavers exposed to any deicing chemicals must be properly cleaned and maintained. We recommend cleaners designed for concrete paving stones. Check with Borgert Products or your hardscape supplier for what product they recommend.

*For industry information concerning maintenance, efflorescence, deicing chemicals and installation guidelines visit [www.icpi.org](http://www.icpi.org).*

**Not all products are stocked in Colorado or Madison.**





MAIN OFFICE  
8646 Ridgewood Road  
P.O. Box 39  
St. Joseph, MN 56374

PHONE 320.363.4671  
FAX 320.363.8516

PERMANENT OUTDOOR DISPLAY  
MN State Fair Grounds  
East Side of Underwood Street  
Between Lee & Randall Avenues

800.622.4952 | [borgertproducts.com](http://borgertproducts.com)

*Your vision, brought to life.*

## RESIDENTIAL WARRANTY

### LIMITED WARRANTY FOR INTERLOCKING CONCRETE PAVERS IN RESIDENTIAL APPLICATIONS AND PERMEABLE CONCRETE PAVERS IN RESIDENTIAL APPLICATIONS.

Borgert Products, Inc. is pleased to provide this lifetime warranty on the structural integrity of its paving stones to the original purchaser for residential applications. A residential application is limited to a driveway, patio or similar use for a single-family residence. The original sales receipt is required for all warranty claims. Borgert Products has a minimum of one year from the time it receives notice to make a determination on a warranty claim. If Borgert Products approves the claim, it may at its option either replace the affected pavers or refund the original purchase price of the pavers to the original purchaser. Color matching is not guaranteed and replacement labor for removal or reinstallation is not included in this warranty. This warranty does not cover normal wear and tear, accidental damage or damage caused by improper installation or abuse such as chipping, breakage, overloading, uneven bedding, abrasion, etc. Efflorescence is not a manufacturing defect and is not covered by this warranty. This warranty is also void if the pavers are not installed using installation methods approved by Borgert Products, Inc., or if the pavers are damaged due to failure to clean and maintain them properly. Please see [www.icpi.org](http://www.icpi.org) for more information regarding installation and maintenance of pavers. Borgert Products, Inc. shall not be liable for incidental, punitive, exemplary, indirect or consequential damages, or lost profits arising under or relating to the purchase and use of its products. This is the only warranty provided by Borgert Products, Inc. Borgert Products, Inc. disclaims all other warranties, expressed or implied.

DISTRIBUTED BY:

