

STRASSEN® WALL CAPS, COLUMNS & FIRE RINGS

PRECAST CAPS

STYLE	CODE	DIMENSIONS	BANDS	CUBES
Strassen® Wall Precast Cap 2½"H x 30"L x 11"W	5SPC	SEE BELOW A	N/A	(21 pcs) 1503#
Strassen® Precast Fire Kit Cap	5SPF	SEE BELOW B (4 units per trapezoid fire ring)	N/A	(16 pcs) 1341#
42" Diameter Precast Pub Table Top	5SPT	SPECIAL ORDER	N/A	

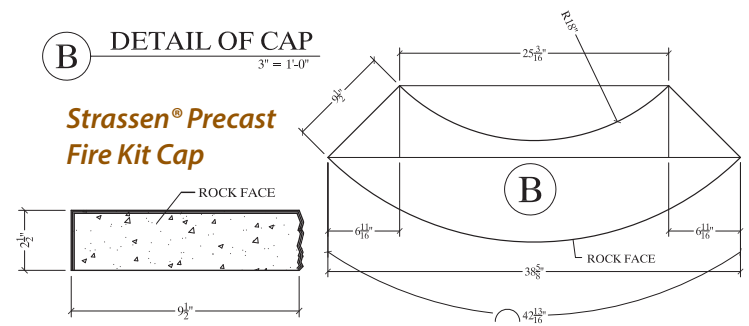
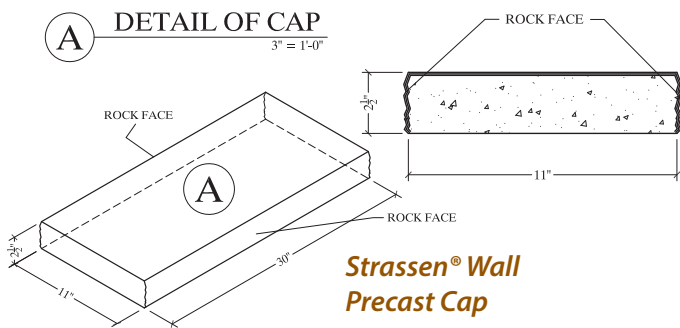

*Precast caps & blocks are not fire rated.

ITEM	WEIGHT/UNIT	UNITS/PALLET	WEIGHT/PALLET
Pillar Cap - Sloped Top or Flat - 24" x 24" x 2¼" <i>*Available with Rockface Edge or Smooth Edge</i>	145#	8	1160#

5PCR - Rockface Edge Sloped
5FCR - Rockface Edge Flat

5PC - Smooth Edge Sloped
5FC - Smooth Edge Flat

CROSS SECTIONS

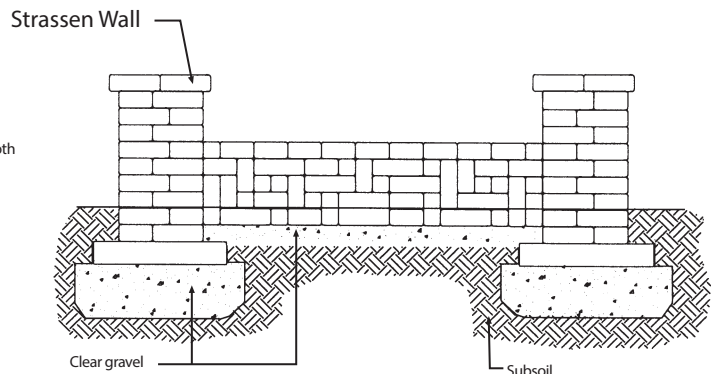
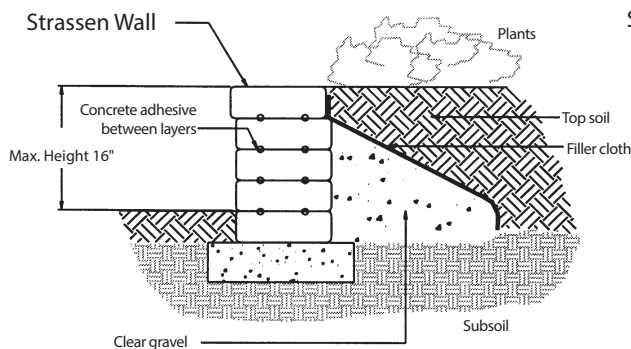

STRASSEN® WALL CAPS, COLUMNS & FIRE RINGS

COLUMN DETAILS

APPROXIMATE COLUMN HEIGHT	NUMBER OF COLUMNS (20" x 20")				
	1	2	3	4	5
2 courses 8 in.	8	16	24	32	40
3 courses 12 in.	12	24	36	48	60
4 courses 16 in.	16	32	48	64	80
5 courses 20 in.	20	40	60	80	100
6 courses 24 in.	24	48	72	96	120
7 courses 28 in.	28	56	84	112	140
8 courses 32 in.	32	64	96	128	160

Adhesive is used to secure corners and top row units.
A 12" solid wall, random pattern = 24 square foot face per cube
An 8" deep wall, running bond = 32 square foot face per cube

Column Details:
Dimension of column = 20" x 20"
Strassen Wall units per foot = 12
Strassen Wall for Caps = 6 units (24" x 24").

Maximum column height not to exceed 32".

FIRE RINGS

8KFR - Fire Ring - Strassen® Wall Trapezoid Fire Kit (No Cut)

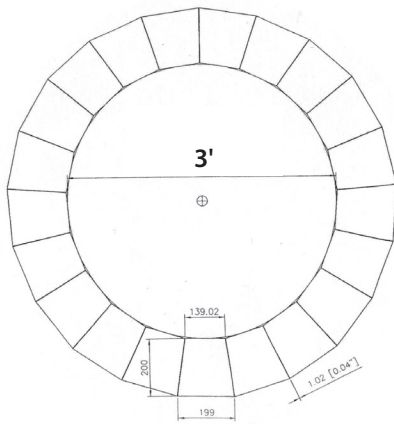

*Outside dimension is 4'4"

PACKING LIST

- (63) Strassen Wall Trapezoid Units (21 units per layer)
- (1) 3' x 12" high Metal Ring
- (3) 10.5 oz. Tubes SRW Adhesive

Wall Colors: Boulder Blend, Flagstaff, Iron Range, MN River, North Shore, & Sterling Gray.

Strassen Precast Fire Kit Cap Colors: Charcoal, Limestone & Brown
(Sold separately) - 4 needed per fire ring.

Optional & Sold Separately
- Strassen® Wall Fire Pit Cap (4 needed per ring)

8KFS - Square Fire Pit Ring - Strassen® Wall Fire Kit (No Cut) - 35½" x 35½" x 12"

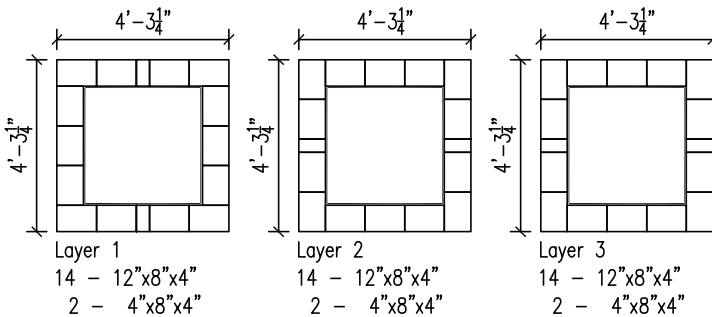

Note: Please allow 5 days notice on kits.
No returns on unused kit items.

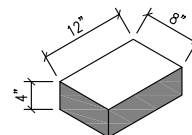

PALLET A
7 7/8" x 11 3/4" x 4"
(200mm x 300mm x 100mm)

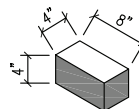

PALLET C
7 7/8" x 4" x 4"
(200mm x 100mm x 100mm)

PACKING LIST

- (42) Pallet A
- (6) Pallet C
- (3) 10.5 oz. Tubes SRW Adhesive
- (1) Steel Square

Wall Colors: Boulder Blend, Flagstaff, Iron Range, MN River, North Shore, & Sterling Gray.