

OUTDOOR FIREPLACE UNITS

Outdoor Fireplace Units

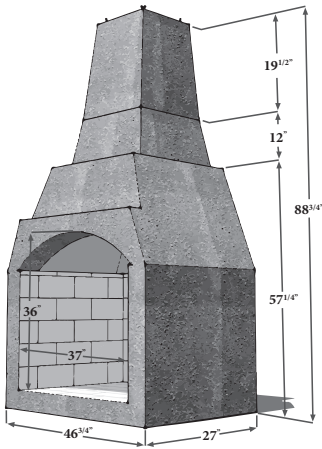

King Arthur - 46"

2065#

5FPA

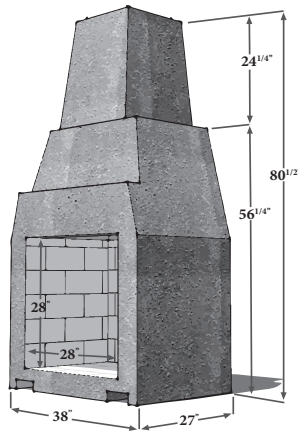

Guinevere - 38"

1698#

5FPG

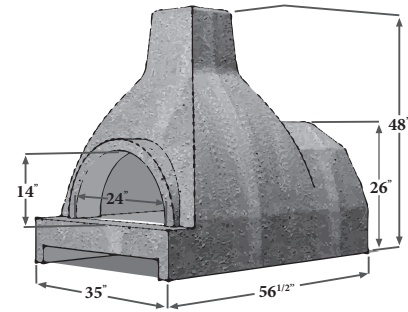

Lancelot Outdoor Oven

2000#

5FPL



KING OF HEARTH'S

OUTDOOR FIREPLACES & OVENS

- Units must be veneered with brick, stone, or Borgert Strassen Wall. Units include fire brick already installed and forking points for ease of setting in place with machine.

- Stress cracks in fireplaces and ovens are micro fractures that are a normal occurrence and do not affect the structural integrity of the unit, nor are grounds for rejection.

- Lancelot oven must be veneered with high density insulation, meshed and scratch coated to ensure a good bond with the veneer.

- All Units must have spark protector with solid top to keep water out, not included.

www.KingofHearths.com

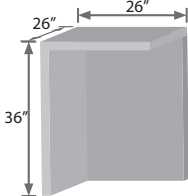
ITEM		CODE	DIMENSIONS	WEIGHT PER UNIT
Side Wood Storage Box		5FSB	36"H x 26"W x 26"D	260#

	KING ARTHUR	GUINEVERE	LANCELOT	SIDE BOX
WEIGHT	2065#	1698#	2000#	260#
ANGLE IRON PIECE	48"	32"	N/A	N/A
STONE VENEER	63 SF	46 SF	26 - 30 SF	12 SF In/Out
LINEAR FOOT CORNERS	36	28	18	36 (Corners may vary)
SPARKER CAP MOUNT SIZE	13" x 13"	13" x 13"	9" x 9"	N/A

OUTDOOR FIREPLACE INSTALLATION & OPERATION

A) ITEMS TO CONSIDER BEFORE INSTALLATION

The outdoor wood fireplaces constructed by The King of Hearths are a very high quality precast fireplace meant to enhance your outdoor living. They are not meant to be used inside a roofed area or building. Clearances to combustible materials are a major consideration. The stack of your fireplace is equipped to accept a chimney cap. **A cap with a spark arrestor is required.** There should be no combustible materials within 8 feet of the cap. The front of the fireplace opening requires a minimum of a 4 foot area where there should be no combustible materials. This includes items as wood decking, furniture and the like. Look for items such as power lines and trees in your yard area to make sure you have a safe clearance.

B) PAD REQUIREMENTS

Your King of Hearths outdoor fireplace is constructed from a high strength light weight concrete. Because of this it may not be necessary to pour a pad to place your fireplace. Because the fireplace itself does not need assembly or to be mortared together a traditional frost foundation may not be required. You will need to remove all organic material (plant matter and topsoil) under your slab or hearth. That material needs to be replaced with gravel material and then compacted for support similar to what is done in preparation for proper sidewalk or driveway installations. Minimum pad dimensions are:

King Arthur 50 inches wide by 40 inches deep
Guinevere 42 inches wide by 32 inches deep

The pad should be poured a minimum of 6 inches deep. A rebar mat needs to be installed in a checkerboard fashion with 12 inch centers. This will keep the pad from splitting and putting undue pressure on the fireplace. If using one of our hearths it will only be necessary to level the hearth. In the event you are using a sidebox it will be necessary to enlarge the pad width by 24 inches. Pads should cure for 7 days before placement of your fireplace.

C) FIREPLACE PLACEMENT

Once your pad or hearth installation is complete you can place your fireplace. Remove the stack from firebox. Your fireplace will come on a sturdy pallet in order to safely get the fireplace close to its final placement. It is not recommended to remove the fireplace from the pallet until it is placed next to the slab or hearth. The pallet will ensure proper weight displacement of the fireplace when coming across rough terrain. On the rear of the firebox there will be 2 fork pockets to lift the fireplace from its pallet and place onto the slab or hearth. It is advisable to center the fireplace on your slab or hearth for equal weight distribution. The stack needs to be placed at this point. Make sure it is centered on the opening in the top of the firebox. It is not necessary to mortar the stack. When you complete your facing with cultured stone, cultured brick or stucco it will lock in and seal your stack. The King Arthur has a 2 piece stack to accommodate the larger firebox.

D) CONDITIONING YOUR FIREPLACE

It is recommended at this point before the facing is applied to build a few small fires. Make sure you have a proper chimney cap installed. Your King Of Hearths fireplace already has the firebrick installed. You can burn right on the bottom of the fireplace or install a log grate if you wish. This preburn is recommended to temper the unit. All materials including concrete will react to heat. This process will help bring the materials to a near final rest before the facing is applied. Your fireplace is meant to burn wood. Burning garbage, wood treated with preservatives or other materials can create temperatures much hotter than wood. In other words protect your investment. **NEVER** use gasoline or diesel fuel to start your fireplace. The preferred method would be using cardboard or kindling for starter.

E) FINISHING YOUR FIREPLACE

Your King Of Hearths fireplace is left purposely with a semi rough surface. For best results mesh and scratch coat the surface to ensure a good bond between the unit and your finish material, whether it be cultured material or natural stone facing or stucco. It is recommended to leave a small gap of a quarter inch between the bottom of the fireplace veneer and pad. The reason for this is to prevent your facing from contacting the hearth or slab during the months when some movement can take place. Your King Of Hearths dealer will be able to make proper recommendations for your application. In the event you select to install one of our sideboxes with your fireplace you will notice that the height is slightly higher than the flat part of the firebox. This is done intentionally to ensure that a proper slope is installed in the veneer applied to prevent water and or ice pooling where the 2 precast units join. It is not necessary to anchor the sidebox to the firebox. The weight of the sidebox and the locking done by the veneer makes this not needed.

F) WARNING

BEFORE YOU START ANY FIRE, MAKE SURE THE BURNING AREA IS COMPLETELY DRY. SPARK ARRESTOR IS REQUIRED BEFORE STARTING A FIRE.

Need help figuring your project? Use our Stone Calculator online at www.borgertproducts.com.

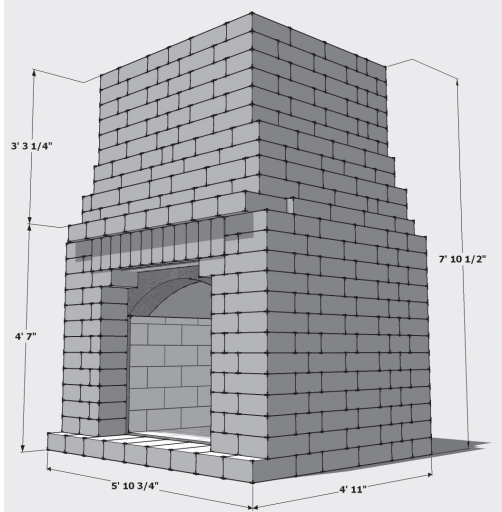

By Layers in Plan View

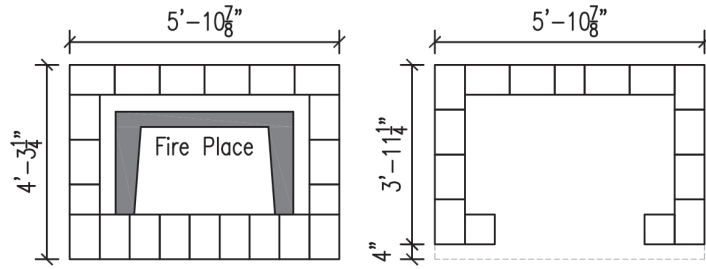

- Layer 1
 19 - 12"x8"x4"
 2 - 8"x8"x4"
 0 - 4"x8"x4"

- Layer 2
 12 - 12"x8"x4"
 3 - 8"x8"x4"
 0 - 4"x8"x4"

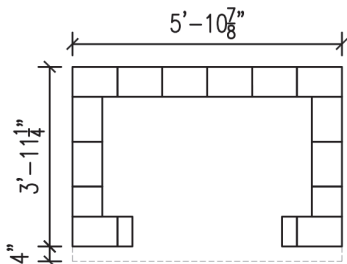

- Layer 3
 12 - 12"x8"x4"
 2 - 8"x8"x4"
 2 - 4"x8"x4"

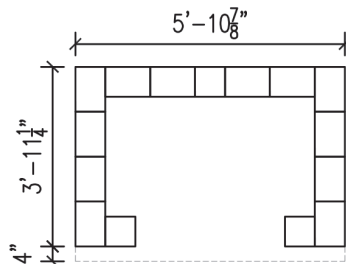

- Layer 4
 12 - 12"x8"x4"
 3 - 8"x8"x4"
 0 - 4"x8"x4"

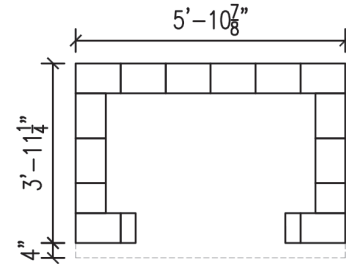

- Layer 5
 12 - 12"x8"x4"
 2 - 8"x8"x4"
 2 - 4"x8"x4"

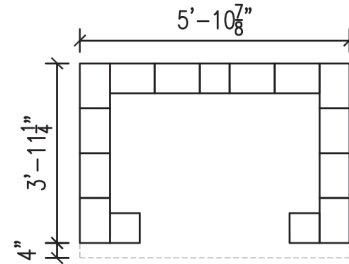

- Layer 6
 12 - 12"x8"x4"
 3 - 8"x8"x4"
 0 - 4"x8"x4"

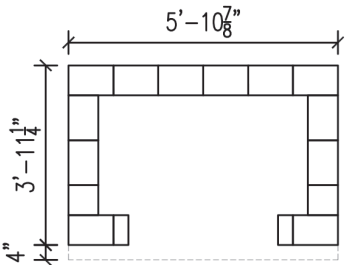

- Layer 7
 12 - 12"x8"x4"
 2 - 8"x8"x4"
 2 - 4"x8"x4"

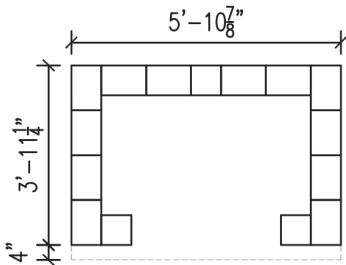

- Layer 8
 12 - 12"x8"x4"
 3 - 8"x8"x4"
 0 - 4"x8"x4"

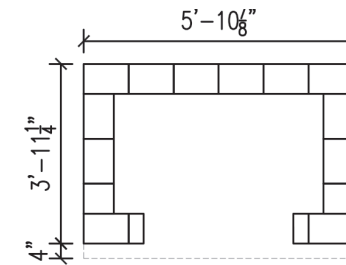

- Layer 9
 12 - 12"x8"x4"
 2 - 8"x8"x4"
 2 - 4"x8"x4"

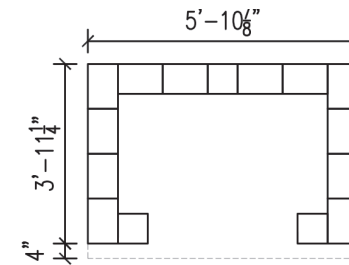

- Layer 10
 12 - 12"x8"x4"
 3 - 8"x8"x4"
 0 - 4"x8"x4"

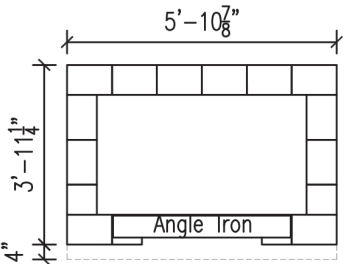

- Layer 11
 12 - 12"x8"x4"
 4 - 8"x8"x4"
 0 - 4"x8"x4"

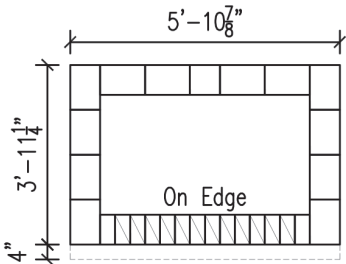

- Layer 12
 12 - 12"x8"x4"
 13 - 8"x8"x4"
 2 - 4"x8"x4"

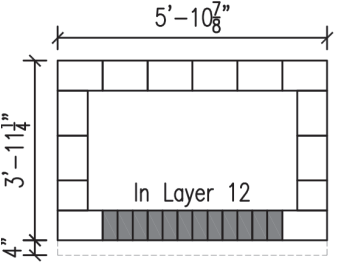

- Layer 13
 12 - 12"x8"x4"
 2 - 8"x8"x4"
 0 - 4"x8"x4"

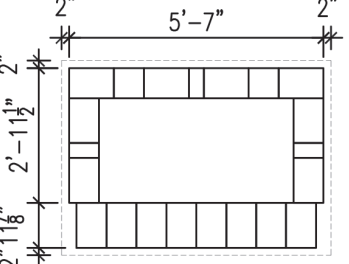

- Layer 14
 16 - 12"x8"x4"
 2 - 8"x8"x4"
 3 - 4"x8"x4"

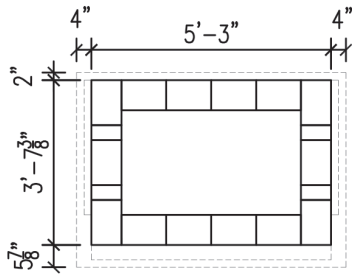

Layer 15

- 14 - 12"x8"x4"
- 0 - 8"x8"x4"
- 4 - 4"x8"x4"

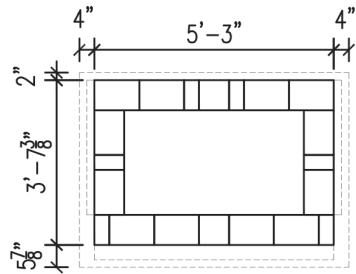

Layer 16

- 12 - 12"x8"x4"
- 2 - 8"x8"x4"
- 6 - 4"x8"x4"

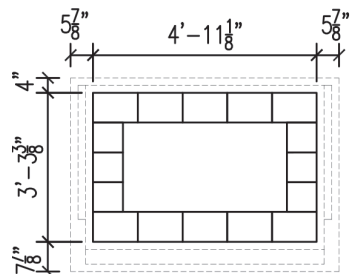

Layer 17

- 10 - 12"x8"x4"
- 6 - 8"x8"x4"
- 0 - 4"x8"x4"

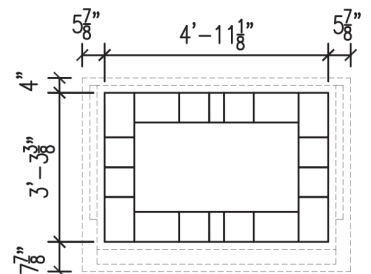

Layer 18

- 8 - 12"x8"x4"
- 8 - 8"x8"x4"
- 2 - 4"x8"x4"

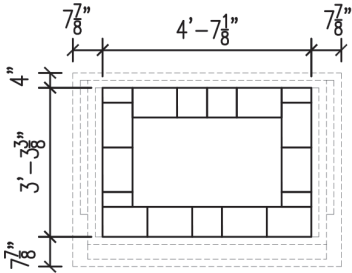

Layer 19

- 10 - 12"x8"x4"
- 3 - 8"x8"x4"
- 4 - 4"x8"x4"

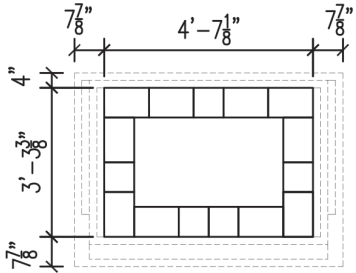

Layer 20

- 10 - 12"x8"x4"
- 5 - 8"x8"x4"
- 0 - 4"x8"x4"

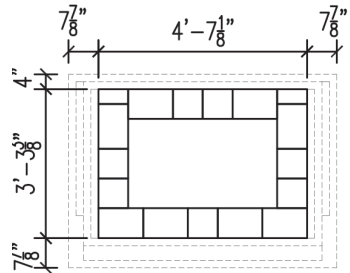

Layer 21

- 8 - 12"x8"x4"
- 7 - 8"x8"x4"
- 2 - 4"x8"x4"

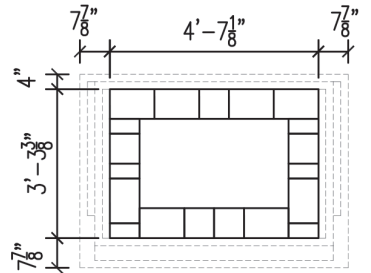

Layer 22

- 8 - 12"x8"x4"
- 5 - 8"x8"x4"
- 6 - 4"x8"x4"

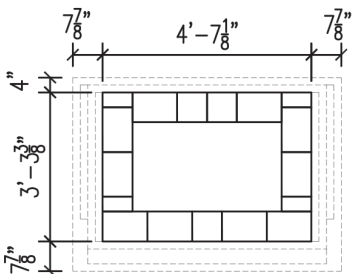

Layer 23

- 10 - 12"x8"x4"
- 3 - 8"x8"x4"
- 4 - 4"x8"x4"

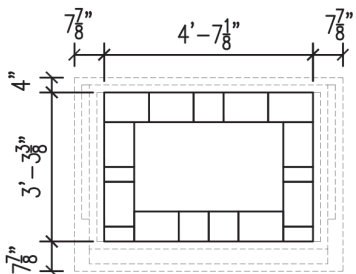

Layer 24

- 10 - 12"x8"x4"
- 3 - 8"x8"x4"
- 4 - 4"x8"x4"

Total Count

- 279 - Strassen Wall Pallet A (4"H x 12"L x 8"D)
- 88 - Strassen Wall Pallet B (4"H x 8"L x 8"D)
- 45 - Strassen Wall Pallet C (4"H x 4"L x 8"D)

NOTE: The dimensions shown are approximate. Due to possible variations with the fireplace insert, positioning of the Strassen® Wall may have to be adjusted, or cut to fit.

Need help figuring your project? Use our Stone Calculator online at www.borgertproducts.com.

38" Guinevere Outdoor Fireplace Layout Guide - (Builds using Strassen® Wall)

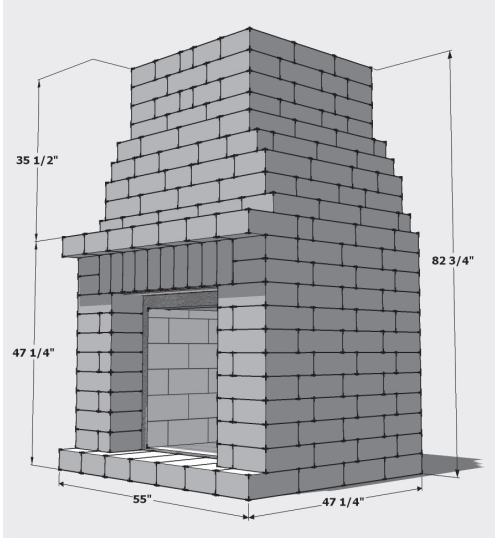

By Layers in Plan View

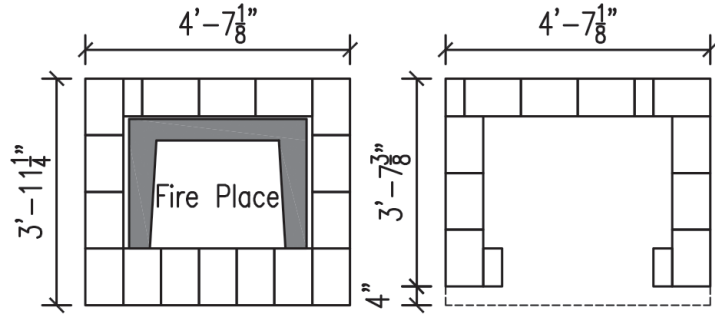

Layer 1
 16 - 12"x8"x4"
 0 - 8"x8"x4"
 4 - 4"x8"x4"

Layer 2
 10 - 12"x8"x4"
 0 - 8"x8"x4"
 4 - 4"x8"x4"

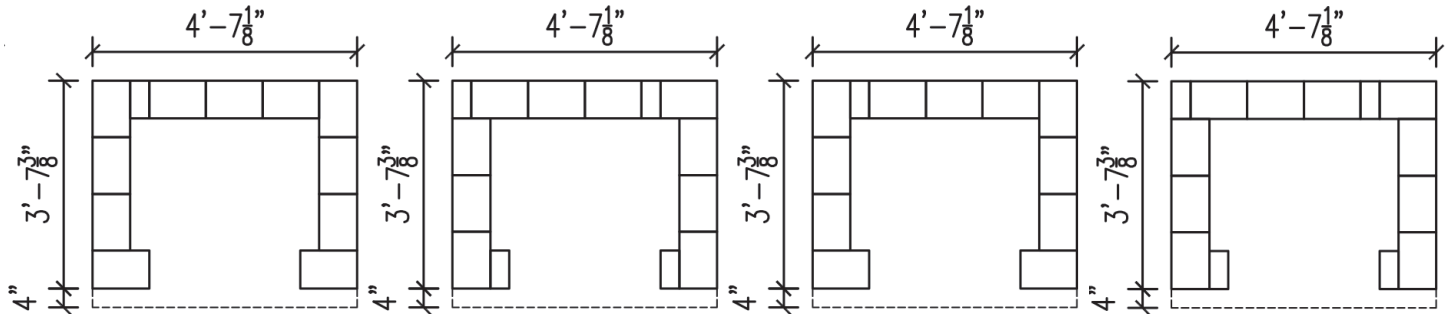

Layer 3
 11 - 12"x8"x4"
 0 - 8"x8"x4"
 1 - 4"x8"x4"

Layer 4
 10 - 12"x8"x4"
 0 - 8"x8"x4"
 4 - 4"x8"x4"

Layer 5
 11 - 12"x8"x4"
 0 - 8"x8"x4"
 1 - 4"x8"x4"

Layer 6
 10 - 12"x8"x4"
 0 - 8"x8"x4"
 4 - 4"x8"x4"

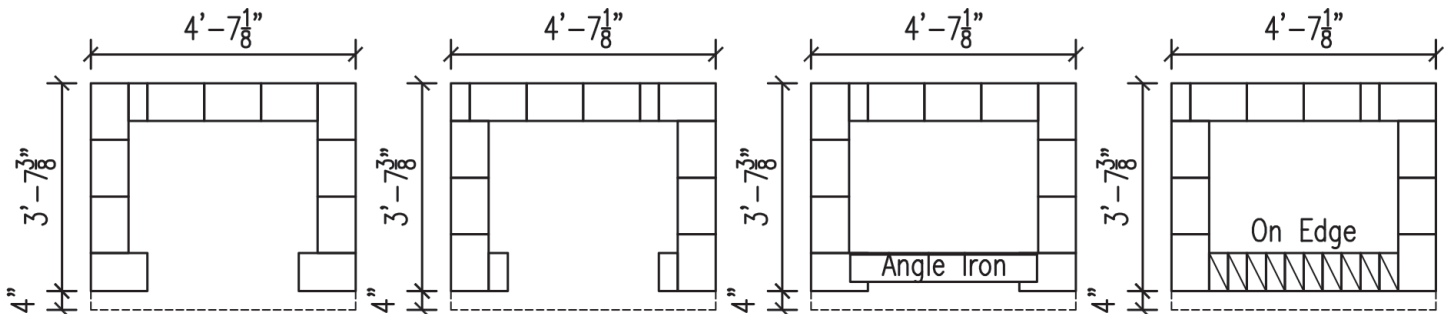

Layer 7
 11 - 12"x8"x4"
 0 - 8"x8"x4"
 1 - 4"x8"x4"

Layer 8
 10 - 12"x8"x4"
 0 - 8"x8"x4"
 4 - 4"x8"x4"

Layer 9
 11 - 12"x8"x4"
 0 - 8"x8"x4"
 1 - 4"x8"x4"

Layer 10
 10 - 12"x8"x4"
 10 - 8"x8"x4"
 2 - 4"x8"x4"

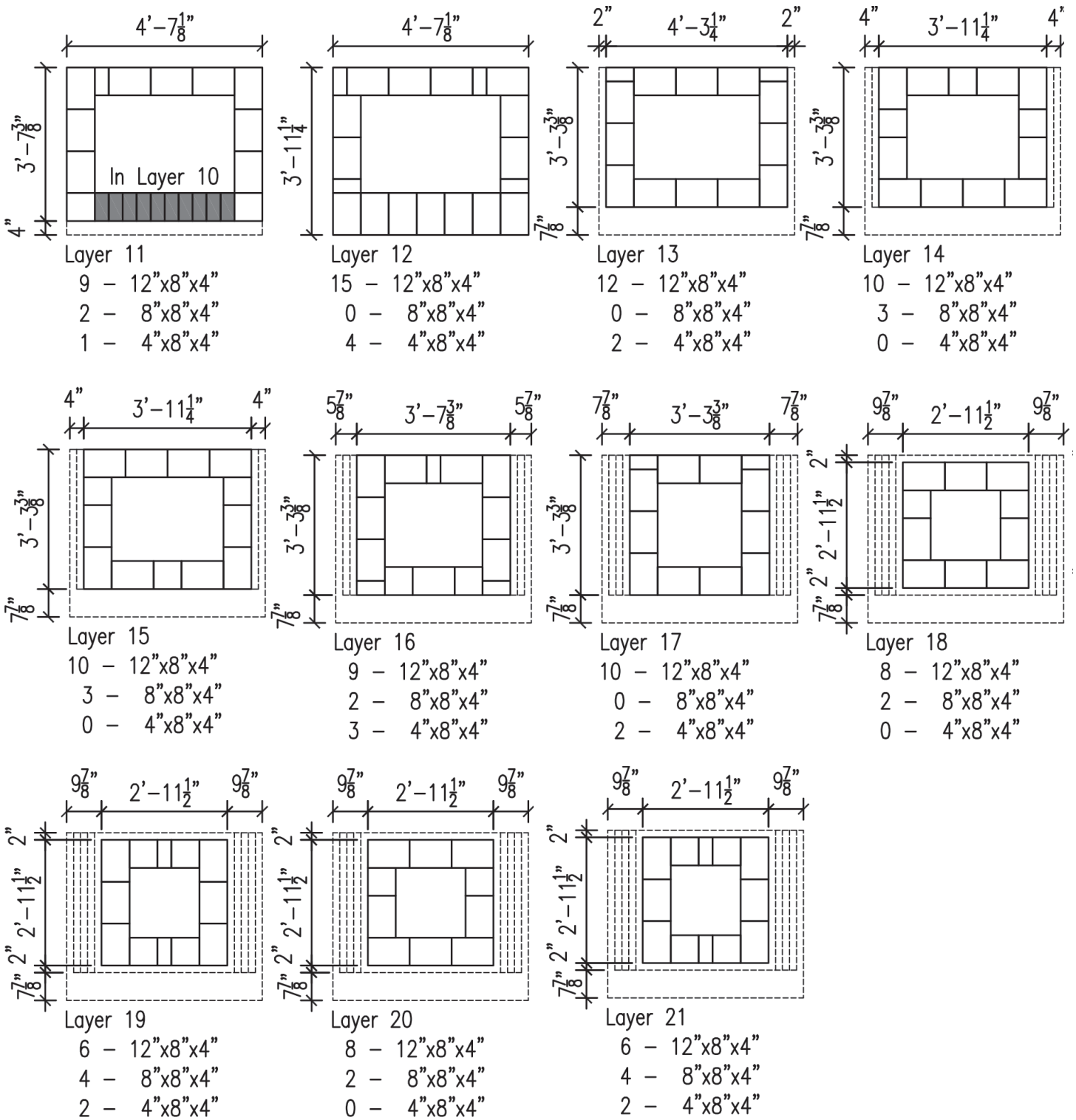

Total Count

- 213 - Strassen Wall Pallet A (4"H x 12"L x 8"D)
- 32 - Strassen Wall Pallet B (4"H x 8"L x 8"D)
- 39 - Strassen Wall Pallet C (4"H x 4"L x 8"W)

NOTE: The dimensions shown are approximate. Due to possible variations with the fireplace insert, positioning of the Strassen® Wall may have to be adjusted, or cut to fit.

Need help figuring your project? Use our Stone Calculator online at www.borgertproducts.com.